

ENGINEERING COOKBOOK

The image features a 3D rendered mechanical component, likely a turbine or engine part, with glowing blue and white edges. The component is set against a dark blue background. The glowing edges create a sense of depth and highlight the complex geometry of the part. The overall aesthetic is technical and futuristic.

*A Handbook
for the
Mechanical
Designer*

ENGINEERING COOKBOOK

**A Handbook
for the
Mechanical Designer**

Second Edition

Copyright 1999

This handy engineering information guide is a token of Loren Cook Company's appreciation to the many fine mechanical designers in our industry.

LOREN COOK COMPANY

Springfield, MO

Table of Contents

Fan Basics

Fan Types	1
Fan Selection Criteria	1
Fan Laws	2
Fan Performance Tables and Curves	2
Fan Testing - Laboratory, Field	2
Air Density Factors for Altitude and Temperature	3
Use of Air Density Factors - An Example	3
Classifications for Spark Resistant Construction	4-5
Impeller Designs - Centrifugal	5-6
Impeller Designs - Axial	7
Terminology for Centrifugal Fan Components	8
Drive Arrangements for Centrifugal Fans	9-10
Rotation & Discharge Designations for Centrifugal Fans	11-12
Motor Positions for Belt or Chain Drive Centrifugal Fans	13
Fan Installation Guidelines	14
Fan Troubleshooting Guide	15

Motor and Drive Basics

Definitions and Formulas	16
Types of Alternating Current Motors	17-18
Motor Insulation Classes	18
Motor Service Factors	19
Locked Rotor KVA/HP	19
Motor Efficiency and EPAct	20
Full Load Current	21-22
General Effect of Voltage and Frequency	23
Allowable Ampacities of Not More Than Three Insulated Conductors	24-25
Belt Drives	26
Estimated Belt Drive Loss	27
Bearing Life	28

System Design Guidelines

General Ventilation	29
Process Ventilation	29
Kitchen Ventilation	30
Sound	31
Rules of Thumb	31-32
Noise Criteria	32

Table of Contents

System Design Guidelines (cont.)

Sound Power and Sound Power Level	32
Sound Pressure and Sound Pressure Level	33
Room Sones —dBA Correlation	33
Noise Criteria Curves.	34
Design Criteria for Room Loudness.	35-36
Vibration.	37
Vibration Severity	38-39

General Ventilation Design

Air Quality Method	40
Air Change Method	40
Suggested Air Changes.	41
Ventilation Rates for Acceptable Indoor Air Quality	42
Heat Gain From Occupants of Conditioned Spaces	43
Heat Gain From Typical Electric Motors.	44
Rate of Heat Gain Commercial Cooking Appliances in Air-Conditioned Areas.	45
Rate of Heat Gain From Miscellaneous Appliances	46
Filter Comparison	46
Relative Size Chart of Common Air Contaminants	47
Optimum Relative Humidity Ranges for Health	48

Duct Design

Backdraft or Relief Dampers	49
Screen Pressure Drop	50
Duct Resistance.	51
Rectangular Equivalent of Round Ducts	52
Typical Design Velocities for HVAC Components.	53
Velocity and Velocity Pressure Relationships	54
U.S. Sheet Metal Gauges	55
Recommended Metal Gauges for Ducts	56
Wind Driven Rain Louvers.	56

Heating & Refrigeration

Moisture and Air Relationships	57
Properties of Saturated Steam	58
Cooling Load Check Figures	59-60
Heat Loss Estimates	61-62
Fuel Comparisons	62
Fuel Gas Characteristics	62

Table of Contents

Heating & Refrigeration (cont.)

Estimated Seasonal Efficiencies of Heating Systems	63
Annual Fuel Use	63-64
Pump Construction Types	64
Pump Impeller Types	64
Pump Bodies	65
Pump Mounting Methods	65
Affinity Laws for Pumps	66
Pumping System Troubleshooting Guide	67-68
Pump Terms, Abbreviations, and Conversion Factors	69
Common Pump Formulas	70
Water Flow and Piping	70-71
Friction Loss for Water Flow	71-72
Equivalent Length of Pipe for Valves and Fittings	73
Standard Pipe Dimensions	74
Copper Tube Dimensions	74
Typical Heat Transfer Coefficients	75
Fouling Factors	76
Cooling Tower Ratings	77
Evaporate Condenser Ratings	78
Compressor Capacity vs. Refrigerant Temperature at 100°F Condensing	78
Refrigerant Line Capacities for 134a	79
Refrigerant Line Capacities for R-22	79
Refrigerant Line Capacities for R-502	80
Refrigerant Line Capacities for R-717	80

Formulas & Conversion Factors

Miscellaneous Formulas	81-84
Area and Circumference of Circles	84-87
Circle Formula	87
Common Fractions of an Inch	87-88
Conversion Factors	88-94
Psychometric Chart	95

Index	96-103
------------------------	--------

Fan Basics

Fan Types

Axial Fan - An axial fan discharges air parallel to the axis of the impeller rotation. As a general rule, axial fans are preferred for high volume, low pressure, and non-ducted systems.

Axial Fan Types

Propeller, Tube Axial and Vane Axial.

Centrifugal Fan - Centrifugal fans discharge air perpendicular to the axis of the impeller rotation. As a general rule, centrifugal fans are preferred for higher pressure ducted systems.

Centrifugal Fan Types

Backward Inclined, Airfoil, Forward Curved, and Radial Tip.

Fan Selection Criteria

Before selecting a fan, the following information is needed.

- Air volume required - CFM
- System resistance - SP
- Air density (Altitude and Temperature)
- Type of service
 - Environment type
 - Materials/vapors to be exhausted
 - Operation temperature
- Space limitations
- Fan type
- Drive type (Direct or Belt)
- Noise criteria
- Number of fans
- Discharge
- Rotation
- Motor position
- Expected fan life in years

Fan Laws

The simplified form of the most commonly used fan laws include.

- **CFM varies directly with RPM**
 $CFM_1/CFM_2 = RPM_1/RPM_2$
- **SP varies with the square of the RPM**
 $SP_1/SP_2 = (RPM_1/RPM_2)^2$
- **HP varies with the cube of the RPM**
 $HP_1/HP_2 = (RPM_1/RPM_2)^3$

Fan Performance Tables and Curves

Performance tables provide a simple method of fan selection. However, it is critical to evaluate fan performance curves in the fan selection process as ***the margin for error is very slim when selecting a fan near the limits of tabular data***. The performance curve also is a valuable tool when evaluating fan performance in the field.

Fan performance tables and curves are based on standard air density of 0.075 lb/ft³. When altitude and temperature differ significantly from standard conditions (sea level and 70° F) performance modification factors must be taken into account to ensure proper performance.

For further information refer to ***Use of Air Density Factors - An Example***, page 3.

Fan Testing - Laboratory, Field

Fans are tested and performance certified under ideal laboratory conditions. When fan performance is measured in field conditions, the difference between the ideal laboratory condition and the actual field installation must be considered. Consideration must also be given to fan inlet and discharge connections as they will dramatically affect fan performance in the field. If possible, readings must be taken in straight runs of ductwork in order to ensure validity. If this cannot be accomplished, motor amperage and fan RPM should be used along with performance curves to estimate fan performance.

For further information refer to ***Fan Installation Guidelines***, page 14.

Fan Basics

Air Density Factors for Altitude and Temperature

Altitude (ft.)	Temperature							
	70	100	200	300	400	500	600	700
0	1.000	.946	.803	.697	.616	.552	.500	.457
1000	.964	.912	.774	.672	.594	.532	.482	.441
2000	.930	.880	.747	.648	.573	.513	.465	.425
3000	.896	.848	.720	.624	.552	.495	.448	.410
4000	.864	.818	.694	.604	.532	.477	.432	.395
5000	.832	.787	.668	.580	.513	.459	.416	.380
6000	.801	.758	.643	.558	.493	.442	.400	.366
7000	.772	.730	.620	.538	.476	.426	.386	.353
8000	.743	.703	.596	.518	.458	.410	.372	.340
9000	.714	.676	.573	.498	.440	.394	.352	.326
10000	.688	.651	.552	.480	.424	.380	.344	.315
15000	.564	.534	.453	.393	.347	.311	.282	.258
20000	.460	.435	.369	.321	.283	.254	.230	.210

Use of Air Density Factors - An Example

A fan is selected to deliver 7500 CFM at 1-1/2 inch SP at an altitude of 6000 feet above sea level and an operating temperature of 200° F. From the table above, **Air Density Factors for Altitude and Temperature**, the air density correction factor is determined to be .643 by using the fan's operating altitude and temperature. Divide the design SP by the air density correction factor.

$$1.5'' \text{ SP} / .643 = 2.33'' \text{ SP}$$

Referring to the fan's performance rating table, it is determined that the fan must operate at 976 RPM to develop the desired 7500 CFM at 6000 foot above sea level and at an operating temperature of 200° F.

The BHP (Brake Horsepower) is determined from the fan's performance table to be 3.53. This is corrected to conditions at altitude by multiplying the BHP by the air density correction factor.

$$3.53 \text{ BHP} \times .643 = 2.27 \text{ BHP}$$

The final operating conditions are determined to be 7500 CFM, 1-1/2" SP, 976 RPM, and 2.27 BHP.

Classifications for Spark Resistant Construction†

Fan applications may involve the handling of potentially explosive or flammable particles, fumes or vapors. Such applications require careful consideration of all system components to insure the safe handling of such gas streams. This AMCA Standard deals only with the fan unit installed in that system. The Standard contains guidelines which are to be used by both the manufacturer and user as a means of establishing general methods of construction. The exact method of construction and choice of alloys is the responsibility of the manufacturer; however, the customer must accept both the type and design with full recognition of the potential hazard and the degree of protection required.

Construction Type

- A. All parts of the fan in contact with the air or gas being handled shall be made of nonferrous material. Steps must also be taken to assure that the impeller, bearings, and shaft are adequately attached and/or restrained to prevent a lateral or axial shift in these components.
- B. The fan shall have a nonferrous impeller and nonferrous ring about the opening through which the shaft passes. Ferrous hubs, shafts, and hardware are allowed provided construction is such that a shift of impeller or shaft will not permit two ferrous parts of the fan to rub or strike. Steps must also be taken to assure the impeller, bearings, and shaft are adequately attached and/or restrained to prevent a lateral or axial shift in these components.
- C. The fan shall be so constructed that a shift of the impeller or shaft will not permit two ferrous parts of the fan to rub or strike.

Notes

1. No bearings, drive components or electrical devices shall be placed in the air or gas stream unless they are constructed or enclosed in such a manner that failure of that component cannot ignite the surrounding gas stream.
2. The user shall electrically ground all fan parts.
3. For this Standard, nonferrous material shall be a material with less than 5% iron or any other material with demonstrated ability to be spark resistant.

†Adapted from AMCA Standard 99-401-86

Fan Basics

Classifications for Spark Resistant Construction (cont.)

4. The use of aluminum or aluminum alloys in the presence of steel which has been allowed to rust requires special consideration. Research by the U.S. Bureau of Mines and others has shown that aluminum impellers rubbing on rusty steel may cause high intensity sparking.

The use of the above Standard in no way implies a guarantee of safety for any level of spark resistance. "Spark resistant construction also does not protect against ignition of explosive gases caused by catastrophic failure or from any airstream material that may be present in a system."

Standard Applications

- Centrifugal Fans
- Axial and Propeller Fans
- Power Roof Ventilators

This standard applies to ferrous and nonferrous metals. The potential questions which may be associated with fans constructed of FRP, PVC, or any other plastic compound were not addressed.

Impeller Designs - Centrifugal

Airfoil - Has the highest efficiency of all of the centrifugal impeller designs with 9 to 16 blades of airfoil contour curved away from the direction of rotation. Air leaves the impeller at a velocity less than its tip speed. Relatively deep blades provide for efficient expansion with the blade passages. For the given duty, the airfoil impeller design will provide for the highest speed of the centrifugal fan designs.

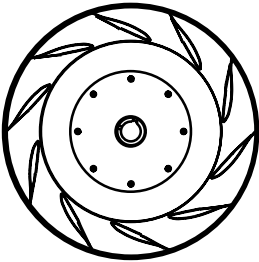

Applications - Primary applications include general heating systems, and ventilating and air conditioning systems. Used in larger sizes for clean air industrial applications providing significant power savings.

Impeller Designs - Centrifugal (cont.)

Backward Inclined, Backward Curved - Efficiency is slightly less than that of the airfoil design. Backward inclined or backward curved blades are single thickness with 9 to 16 blades curved or inclined away from the direction of rotation. Air leaves the impeller at a velocity less than its tip speed. Relatively deep blades provide efficient expansion with the blade passages.

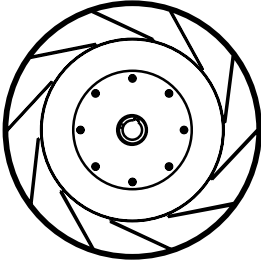

Applications - Primary applications include general heating systems, and ventilating and air conditioning systems. Also used in some industrial applications where the airfoil blade is not acceptable because of a corrosive and/or erosive environment.

Radial - Simplest of all centrifugal impellers and least efficient. Has high mechanical strength and the impeller is easily repaired. For a given point of rating, this impeller requires medium speed. Classification includes radial blades and modified radial blades), usually with 6 to 10 blades.

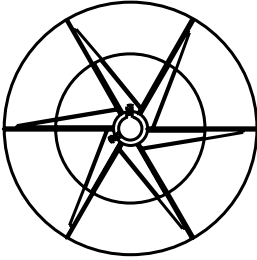

Applications - Used primarily for material handling applications in industrial plants. Impeller can be of rugged construction and is simple to repair in the field. Impeller is sometimes coated with special material. This design also is used for high pressure industrial requirements and is not commonly found in HVAC applications.

Forward Curved - Efficiency is less than airfoil and backward curved bladed impellers. Usually fabricated at low cost and of lightweight construction. Has 24 to 64 shallow blades with both the heel and tip curved forward. Air leaves the impeller at velocities greater than the impeller tip speed. Tip speed and primary energy transferred to the air is the result of high impeller velocities. For the given duty, the wheel is the smallest of all of the centrifugal types and operates most efficiently at lowest speed.

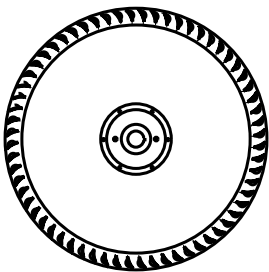

Applications - Primary applications include low pressure heating, ventilating, and air conditioning applications such as domestic furnaces, central station units, and packaged air conditioning equipment from room type to roof top units.

Fan Basics

Impeller Designs - Axial

Propeller - Efficiency is low and usually limited to low pressure applications. Impeller construction costs are also usually low. General construction features include two or more blades of single thickness attached to a relatively small hub. Energy transfer is primarily in form of velocity pressure.

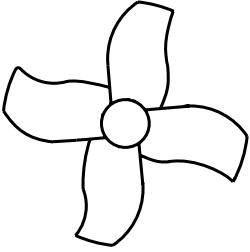

Applications - Primary applications include low pressure, high volume air moving applications such as air circulation within a space or ventilation through a wall without attached duct work. Used for replacement air applications.

Tube Axial - Slightly more efficient than propeller impeller design and is capable of developing a more useful static pressure range. Generally, the number of blades range from 4 to 8 with the hub normally less than 50 percent of fan tip diameter. Blades can be of airfoil or single thickness cross section.

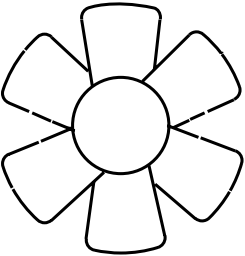

Applications - Primary applications include low and medium pressure ducted heating, ventilating, and air conditioning applications where air distribution on the downstream side is not critical. Also used in some industrial applications such as drying ovens, paint spray booths, and fume exhaust systems.

Vane Axial - Solid design of the blades permits medium to high pressure capability at good efficiencies. The most efficient fans of this type have airfoil blades. Blades are fixed or adjustable pitch types and the hub is usually greater than 50 percent of the fan tip diameter.

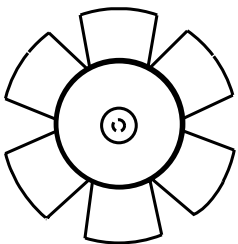

Applications - Primary applications include general heating, ventilating, and air conditioning systems in low, medium, and high pressure applications. Advantage where straight through flow and compact installation are required. Air distribution on downstream side is good. Also used in some industrial applications such as drying ovens, paint spray booths, and fume exhaust systems. Relatively more compact than comparable centrifugal type fans for the same duty.

Terminology for Centrifugal Fan Components

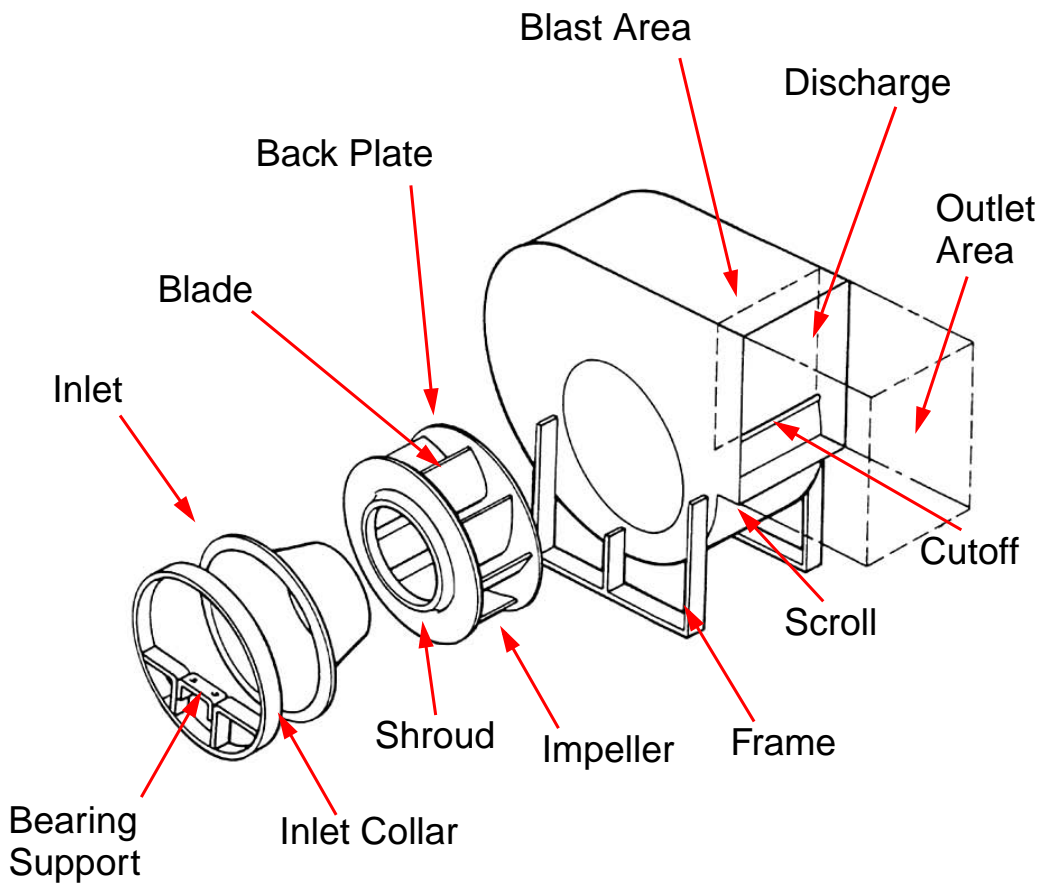
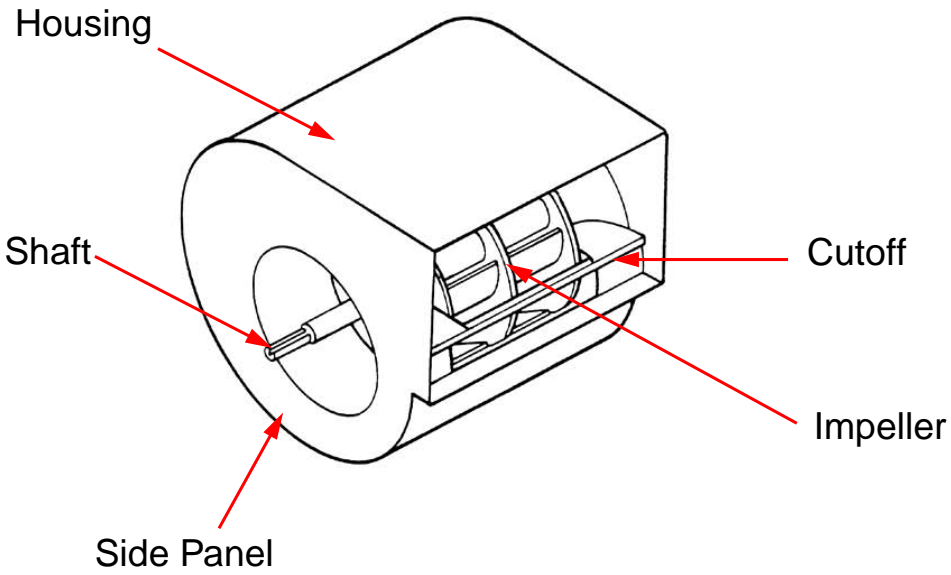

Fan Basics

Drive Arrangements for Centrifugal Fans†

SW - Single Width, **SI** - Single Inlet

DW - Double Width, **DI** - Double Inlet

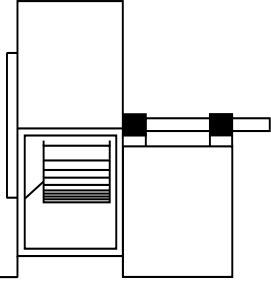

Arr. 1 SWSI - For belt drive or direct drive connection. Impeller over-hung. Two bearings on base.

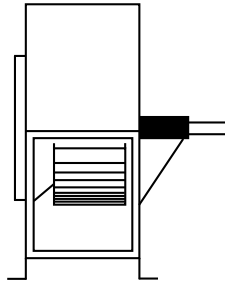

Arr. 2 SWSI - For belt drive or direct drive connection. Impeller over-hung. Bearings in bracket supported by fan housing.

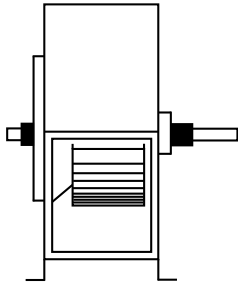

Arr. 3 SWSI - For belt drive or direct drive connection. One bearing on each side supported by fan housing.

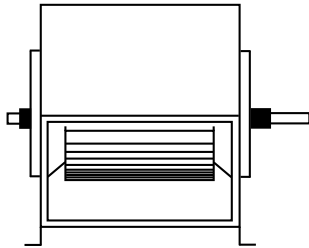

Arr. 3 DWDI - For belt drive or direct connection. One bearing on each side and supported by fan housing.

†Adapted from AMCA Standard 99-2404-78

Drive Arrangements for Centrifugal Fans (cont.)

SW - Single Width, **SI** - Single Inlet

DW - Double Width, **DI** - Double Inlet

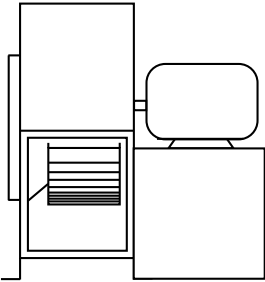

Arr. 4 SWSI - For direct drive. Impeller over-hung on prime mover shaft. No bearings on fan. Prime mover base mounted or integrally directly connected.

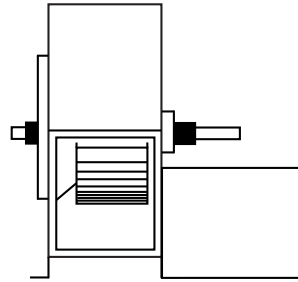

Arr. 7 SWSI - For belt drive or direct connection. Arrangement 3 plus base for prime mover.

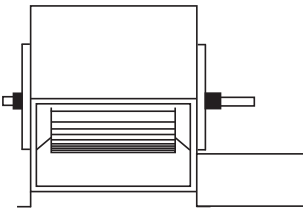

Arr. 7 DWDI - For belt drive or direct connection. Arrangement 3 plus base for prime mover.

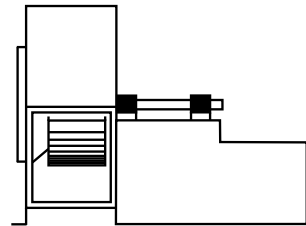

Arr. 8 SWSI - For belt drive or direct connection. Arrangement 1 plus extended base for prime mover.

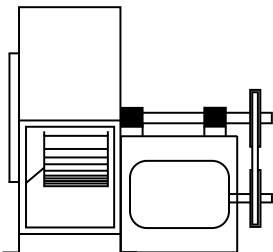

Arr. 9 SWSI - For belt drive. Impeller overhung, two bearings, with prime mover outside base.

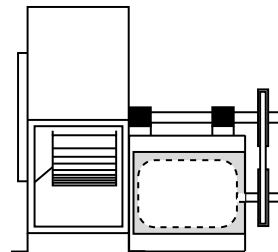

Arr. 10 SWSI - For belt drive. Impeller overhung, two bearings, with prime mover inside base.

Fan Basics

Rotation & Discharge Designations for Centrifugal Fans*

Top Horizontal

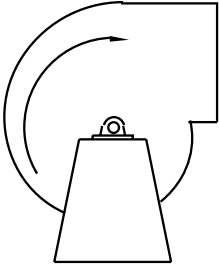

Clockwise

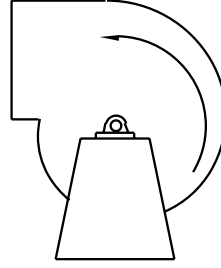

Counterclockwise

Top Angular Down

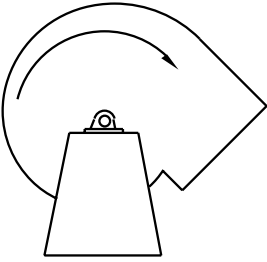

Clockwise

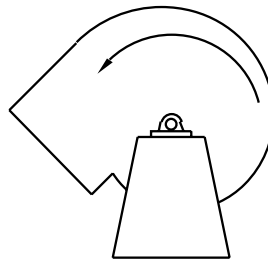

Counterclockwise

Top Angular Up

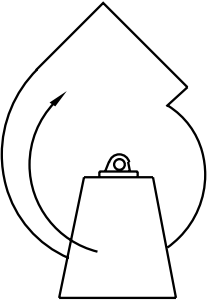

Clockwise

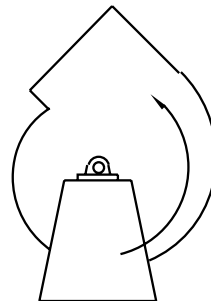

Counterclockwise

Down Blast

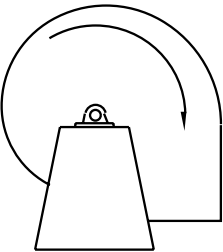

Clockwise

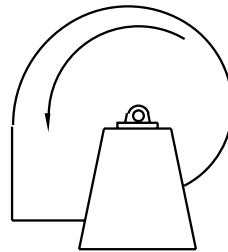

Counterclockwise

* Rotation is always as viewed from drive side.

Rotation & Discharge Designations for Centrifugal Fans* (cont.)

Up Blast

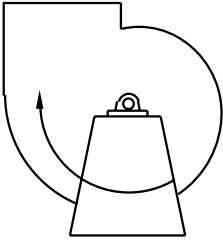

Clockwise

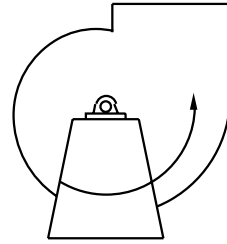

Counterclockwise

Bottom Horizontal

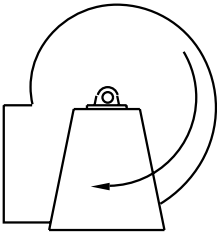

Clockwise

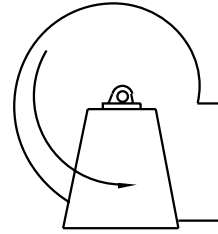

Counterclockwise

Bottom Angular Down

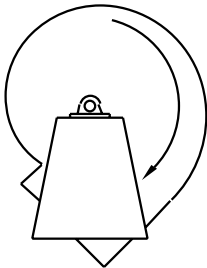

Clockwise

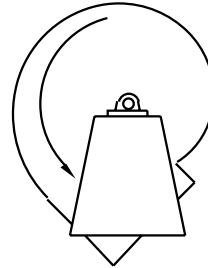

Counterclockwise

Bottom Angular Up

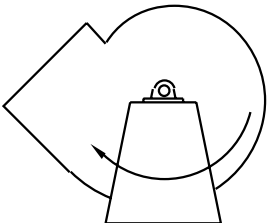

Clockwise

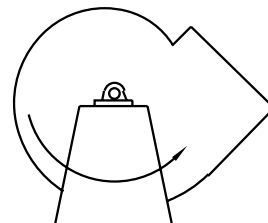

Counterclockwise

* Rotation is always as viewed from drive side.

Fan Basics

Motor Positions for Belt Drive Centrifugal Fans†

To determine the location of the motor, face the drive side of the fan and pick the proper motor position designated by the letters W, X, Y or Z as shown in the drawing below.

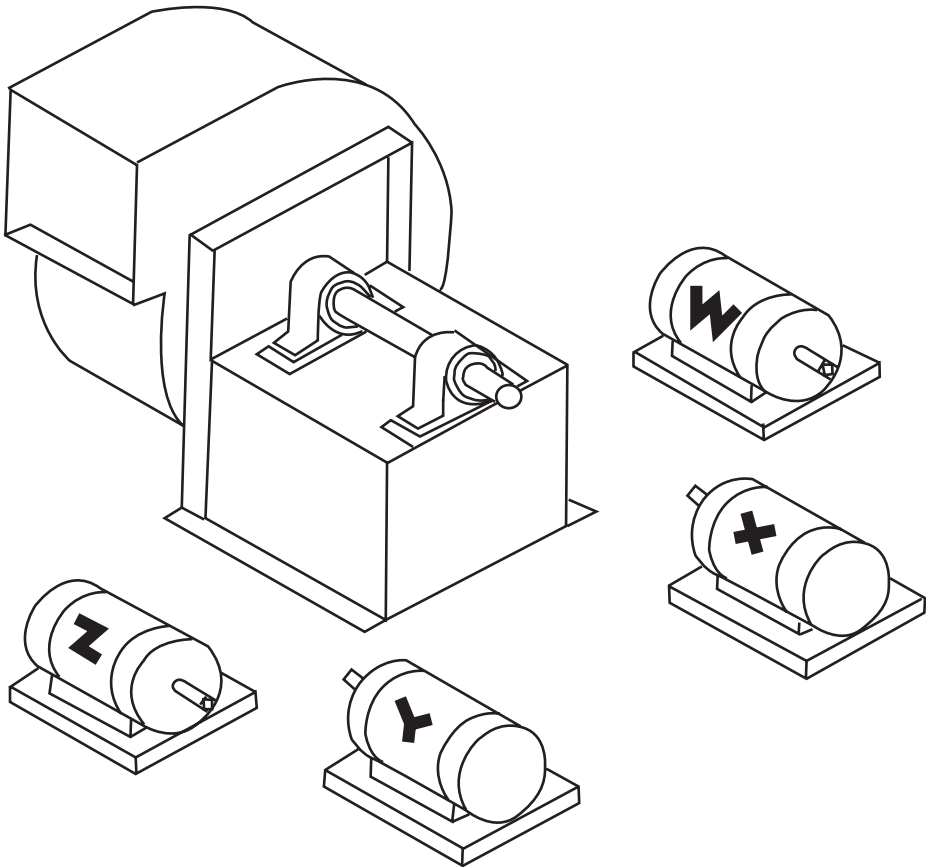

†Adapted from AMCA Standard 99-2404-78

Fan Installation Guidelines

Centrifugal Fan Conditions Typical Inlet Conditions

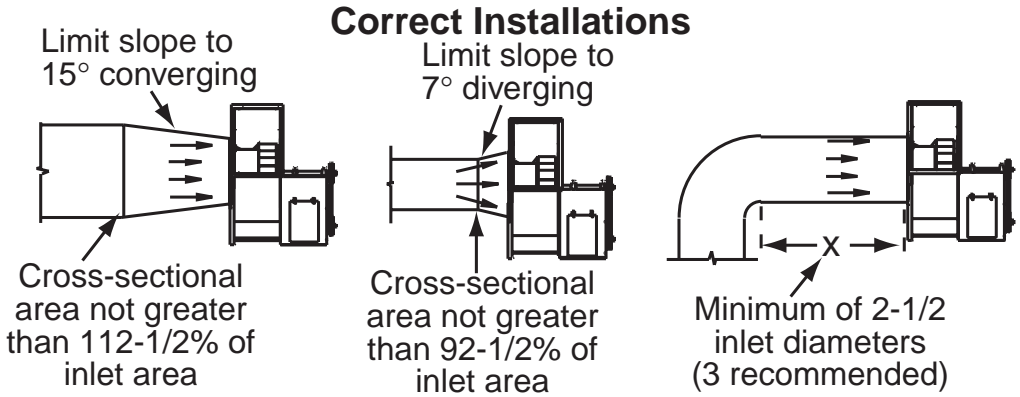

Incorrect Installations

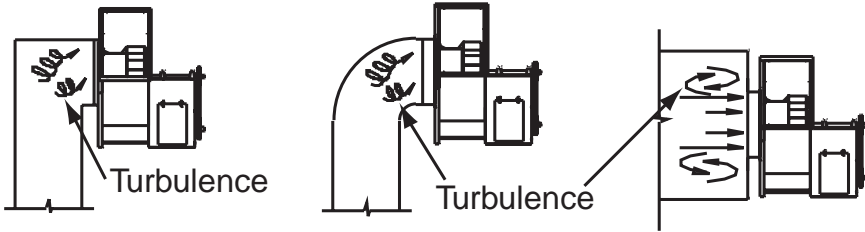

Typical Outlet Conditions

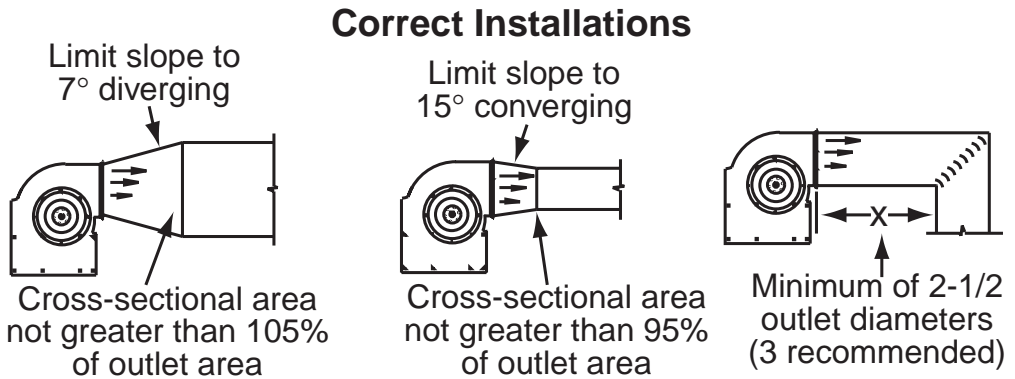

Incorrect Installations

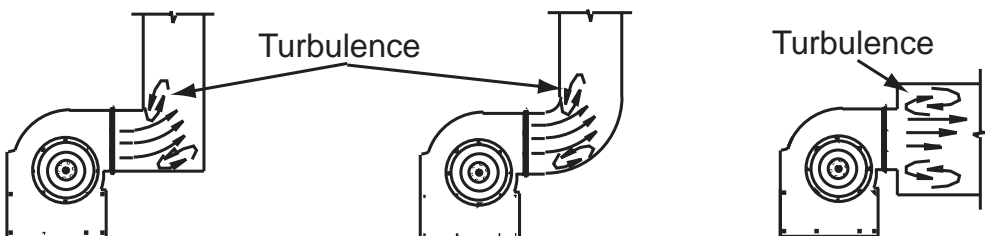

Fan Basics

Fan Troubleshooting Guide

Low Capacity or Pressure

- Incorrect direction of rotation – Make sure the fan rotates in same direction as the arrows on the motor or belt drive assembly.
- Poor fan inlet conditions –There should be a straight, clear duct at the inlet.
- Improper wheel alignment.

Excessive Vibration and Noise

- Damaged or unbalanced wheel.
- Belts too loose; worn or oily belts.
- Speed too high.
- Incorrect direction of rotation. Make sure the fan rotates in same direction as the arrows on the motor or belt drive assembly.
- Bearings need lubrication or replacement.
- Fan surge.

Overheated Motor

- Motor improperly wired.
- Incorrect direction of rotation. Make sure the fan rotates in same direction as the arrows on the motor or belt drive assembly.
- Cooling air diverted or blocked.
- Improper inlet clearance.
- Incorrect fan RPM.
- Incorrect voltage.

Overheated Bearings

- Improper bearing lubrication.
- Excessive belt tension.

Motor and Drive Basics

Definitions and Formulas

Alternating Current: electric current that alternates or reverses at a defined frequency, typically 60 cycles per second (Hertz) in the U.S. and 50 Hz in Canada and other nations.

Breakdown Torque: the maximum torque a motor will develop with rated voltage and frequency applied without an abrupt drop in speed.

Efficiency: a rating of how much input power an electric motor converts to actual work at the rotating shaft expressed in percent.

$$\% \text{ efficiency} = (\text{power out} / \text{power in}) \times 100$$

Horsepower: a rate of doing work expressed in foot-pounds per minute.

$$HP = (RPM \times \text{torque}) / 5252 \text{ lb-ft.}$$

Locked Rotor Torque: the minimum torque that a motor will develop at rest for all angular positions of the rotor with rated voltage and frequency applied.

Rated Load Torque: the torque necessary to produce rated horsepower at rated-load speed.

Single Phase AC: typical household type electric power consisting of a single alternating current at 110-115 volts.

Slip: the difference between synchronous speed and actual motor speed. Usually expressed in percent slip.

$$\% \text{ slip} = \frac{(\text{synchronous speed} - \text{actual speed})}{\text{synchronous speed}} \times 100$$

Synchronous speed: the speed of the rotating magnetic field in an electric motor.

$$\text{Synchronous Speed} = (60 \times 2f) / p$$

Where: f = frequency of the power supply

p = number of poles in the motor

Three Phase AC: typical industrial electric power consisting of 3 alternating currents of equal frequency differing in phase of 120 degrees from each other. Available in voltages ranging from 200 to 575 volts for typical industrial applications.

Torque: a measure of rotational force defined in foot-pounds or Newton-meters.

$$\text{Torque} = (HP \times 5252 \text{ lb-ft.}) / RPM$$

Motor and Drive Basics

Types of Alternating Current Motors

Single Phase AC Motors

This type of motor is used in fan applications requiring less than one horsepower. There are four types of motors suitable for driving fans as shown in the chart below. All are single speed motors that can be made to operate at two or more speeds with internal or external modifications.

Single Phase AC Motors (60hz)

Motor Type	HP Range	Efficiency	Slip	Poles/ RPM	Use
Shaded Pole	1/6 to 1/4 hp	low (30%)	high (14%)	4/1550 6/1050	small direct drive fans (low start torque)
Perm-split Cap.	Up to 1/3 hp	medium (50%)	medium (10%)	4/1625 6/1075	small direct drive fans (low start torque)
Split-phase	Up to 1/2 hp	medium-high (65%)	low (4%)	2/3450 4/1725 6/1140 8/850	small belt drive fans (good start torque)
Capacitor-start	1/2 to 3/4 hp	medium-high (65%)	low (4%)	2/3450 4/1725 6/1140 8/850	small belt drive fans (good start torque)

Three-phase AC Motors

The most common motor for fan applications is the three-phase squirrel cage induction motor. The squirrel-cage motor is a constant speed motor of simple construction that produces relatively high starting torque. The operation of a three-phase motor is simple: the three phase current produces a rotating magnetic field in the stator. This rotating magnetic field causes a magnetic field to be set up in the rotor. The attraction and repulsion of these two magnetic fields causes the rotor to turn.

Squirrel cage induction motors are wound for the following speeds:

Number of Poles	60 Hz Synchronous Speed	50 Hz Synchronous Speed
2	3600	3000
4	1800	1500
6	1200	1000
8	900	750

Motor and Drive Basics

Types of Alternating Current Motors

Actual motor speed is somewhat less than synchronous speed due to slip. A motor with a slip of 5% or less is called a “normal slip” motor. A normal slip motor may be referred to as a constant speed motor because the speed changes very little with load variations. In specifying the speed of the motor on the nameplate most motor manufacturers will use the actual speed of the motor which will be less than the synchronous speed due to slip.

NEMA has established several different torque designs to cover various three-phase motor applications as shown in the chart.

NEMA Design	Starting Current	Locked Rotor	Breakdown Torque	% Slip
B	Medium	Medium Torque	High	Max. 5%
C	Medium	High Torque	Medium	Max. 5%
D	Medium	Extra-High Torque	Low	5% or more

NEMA Design	Applications
B	Normal starting torque for fans, blowers, rotary pumps, compressors, conveyors, machine tools. Constant load speed.
C	High inertia starts - large centrifugal blowers, fly wheels, and crusher drums. Loaded starts such as piston pumps, compressors, and conveyers. Constant load speed.
D	Very high inertia and loaded starts. Also considerable variation in load speed. Punch presses, shears and forming machine tools. Cranes, hoists, elevators, and oil well pumping jacks.

Motor Insulation Classes

Electric motor insulation classes are rated by their resistance to thermal degradation. The four basic insulation systems normally encountered are Class A, B, F, and H. Class A has a temperature rating of 105°C (221°F) and each step from A to B, B to F, and F to H involves a 25° C (77° F) jump. The insulation class in any motor must be able to withstand at least the maximum ambient temperature plus the temperature rise that occurs as a result of continuous full load operation.

Motor and Drive Basics

Motor Service Factors

Some motors can be specified with service factors other than 1.0. This means the motor can handle loads above the rated horsepower. A motor with a 1.15 service factor can handle a 15% overload, so a 10 horsepower motor can handle 11.5 HP of load. In general for good motor reliability, service factor should not be used for basic load calculations. By not loading the motor into the service factor under normal use the motor can better withstand adverse conditions that may occur such as higher than normal ambient temperatures or voltage fluctuations as well as the occasional overload.

Locked Rotor KVA/HP

Locked rotor kva per horsepower is a rating commonly specified on motor nameplates. The rating is shown as a code letter on the nameplate which represents various kva/hp ratings.

Code Letter	kva/hp	Code Letter	kva/hp
A	0 - 3.15	L	9.0 - 10.0
B	3.15 - 3.55	M	10.0 - 11.2
C	3.55 - 4.0	N	11.2 - 12.5
D	4.0 - 4.5	P	12.5 - 14.0
E	4.5 - 5.0	R	14.0 - 16.0
F	5.0 - 5.6	S	16.0 - 18.0
G	5.6 - 6.3	T	18.0 - 20.0
H	6.3 - 7.1	U	20.0 - 22.4
J	7.1 - 8.0	V	22.4 and up
K	8.0 - 9.0		

The nameplate code rating is a good indication of the starting current the motor will draw. A code letter at the beginning of the alphabet indicates a low starting current and a letter at the end of the alphabet indicates a high starting current. Starting current can be calculated using the following formula:

$$\text{Starting current} = (1000 \times \text{hp} \times \text{kva/hp}) / (1.73 \times \text{Volts})$$

Motor and Drive Basics

Motor Efficiency and EPAcT

As previously defined, motor efficiency is a measure of how much input power a motor converts to torque and horsepower at the shaft. Efficiency is important to the operating cost of a motor and to overall energy use in our economy. It is estimated that over 60% of the electric power generated in the United States is used to power electric motors. On October 24, 1992, the U.S. Congress signed into law the Energy Policy Act (EPAcT) that established mandated efficiency standards for general purpose, three-phase AC industrial motors from 1 to 200 horsepower. EPAcT became effective on October 24, 1997.

**Department of Energy
General Purpose Motors
Required Full-Load Nominal Efficiency
Under EPAcT-92**

Motor HP	Nominal Full-Load Efficiency					
	Open Motors			Enclosed Motors		
	6 Pole	4 Pole	2 Pole	6 Pole	4 Pole	2 Pole
1	80.0	82.5		80.0	82.5	75.5
1.5	84.0	84.0	82.5	85.5	84.0	82.5
2	85.5	84.0	84.0	86.5	84.0	84.0
3	86.5	86.5	84.0	87.5	87.5	85.5
5	87.5	87.5	85.5	87.5	87.5	87.5
7.5	88.5	88.5	87.5	89.5	89.5	88.5
10	90.2	89.5	88.5	89.5	89.5	89.5
15	90.2	91.0	89.5	90.2	91.0	90.2
20	91.0	91.0	90.2	90.2	91.0	90.2
25	91.7	91.7	91.0	91.7	92.4	91.0
30	92.4	92.4	91.0	91.7	92.4	91.0
40	93.0	93.0	91.7	93.0	93.0	91.7
50	93.0	93.0	92.4	93.0	93.0	92.4
60	93.6	93.6	93.0	93.6	93.6	93.0
75	93.6	94.1	93.0	93.6	94.1	93.0
100	94.1	94.1	93.0	94.1	94.5	93.6
125	94.1	94.5	93.6	94.1	94.5	94.5
150	94.5	95.0	93.6	95.0	95.0	94.5
200	94.5	95.0	94.5	95.0	95.0	95.0

Motor and Drive Basics

Full Load Current†

Single Phase Motors

HP	115V	200V	230V
1/6	4.4	2.5	2.2
1/4	5.8	3.3	2.9
1/3	7.2	4.1	3.6
1/2	9.8	5.6	4.9
3/4	13.8	7.9	6.9
1	16	9.2	8
1-1/2	20	11.5	10
2	24	13.8	12
3	34	19.6	17
5	56	32.2	28
7-1/2	80	46	40
10	100	57.5	50

† Based on Table 430-148 of the National Electric Code®, 1993.
For motors running at usual speeds and motors with normal torque characteristics.

Motor and Drive Basics

Full Load Current†

Three Phase Motors

A-C Induction Type-Squirrel Cage and Wound Rotor Motors*

HP	115V	200V	230V	460V	575V	2300V	4000V
1/2	4	2.3	2	1	0.8		
3/4	5.6	3.2	2.8	1.4	1.1		
1	7.2	4.15	3.6	1.8	1.4		
1-1/2	10.4	6	5.2	2.6	2.1		
2	13.6	7.8	6.8	3.4	2.7		
3		11	9.6	4.8	3.9		
5		17.5	15.2	7.6	6.1		
7-1/2		25	22	11	9		
10		32	28	14	11		
15		48	42	21	17		
20		62	54	27	22		
25		78	68	34	27		
30		92	80	40	32		
40		120	104	52	41		
50		150	130	65	52		
60		177	154	77	62	15.4	8.8
75		221	192	96	77	19.2	11
100		285	248	124	99	24.8	14.3
125		358	312	156	125	31.2	18
150		415	360	180	144	36	20.7
200		550	480	240	192	48	27.6
Over 200 hp Approx. Amps/hp		2.75	2.4	1.2	0.96	.24	.14

† Branch-circuit conductors supplying a single motor shall have an ampacity not less than 125 percent of the motor full-load current rating.

Based on Table 430-150 of the **National Electrical Code®**, 1993. For motors running at speeds usual for belted motors and with normal torque characteristics.

* For conductor sizing only

Motor and Drive Basics

General Effect of Voltage and Frequency Variations on Induction Motor Characteristics

Characteristic	Voltage	
	110%	90%
Starting Torque	Up 21%	Down 19%
Maximum Torque	Up 21%	Down 19%
Percent Slip	Down 15-20%	Up 20-30%
Efficiency - Full Load	Down 0-3%	Down 0-2%
3/4 Load	0 - Down Slightly	Little Change
1/2 Load	Down 0-5%	Up 0-1%
Power Factor - Full Load	Down 5-15%	Up 1-7%
3/4 Load	Down 5-15%	Up 2-7%
1/2 Load	Down 10-20%	Up 3-10%
Full Load Current	Down Slightly to Up 5%	Up 5-10%
Starting Current	Up 10%	Down 10%
Full Load - Temperature Rise	Up 10%	Down 10-15%
Maximum Overload Capacity	Up 21%	Down 19%
Magnetic Noise	Up Slightly	Down Slightly

Characteristic	Frequency	
	105%	95%
Starting Torque	Down 10%	Up 11%
Maximum Torque	Down 10%	Up 11%
Percent Slip	Up 10-15%	Down 5-10%
Efficiency - Full Load	Up Slightly	Down Slightly
3/4 Load	Up Slightly	Down Slightly
1/2 Load	Up Slightly	Down Slightly
Power Factor - Full Load	Up Slightly	Down Slightly
3/4 Load	Up Slightly	Down Slightly
1/2 Load	Up Slightly	Down Slightly
Full Load Current	Down Slightly	Up Slightly
Starting Current	Down 5%	Up 5%
Full Load - Temperature Rise	Down Slightly	Up Slightly
Maximum Overload Capacity	Down Slightly	Up Slightly
Magnetic Noise	Down Slightly	Up Slightly

Motor and Drive Basics

Allowable Ampacities of Not More Than Three Insulated Conductors

Rated 0-2000 Volts, 60° to 90°C (140° to 194°F), in Raceway or Cable or Earth (directly buried). Based on ambient air temperature of 30°C (86°F).

AWG kcmil	Temperature Rating of Copper Conductor		
	60°C (140°F) Types TW†, UF†	75°C (167°F) Types FEPW†, RH†, RHW†, THHW†, THW†, THWN†, XHHW†, USE†, ZW†	90°C (194°F) Types TA, TBS, SA, SIS, FEP†, FEPB†, MI, RHH†, RHW-2, THHN†, THHW†, THW-2, USE-2, XHH, XHHW†, XHHW-2, ZW-2
18	—	—	14
16	—	—	18
14	20†	20†	25†
12	25†	25†	30†
10	30	35†	40†
8	40	50	55
6	55	65	75
4	70	85	95
3	85	100	110
2	95	115	130
1	110	130	150
1/0	125	150	170
2/0	145	175	195
3/0	165	200	225
4/0	195	230	260
250	215	255	290
300	240	285	320
350	260	310	350
400	280	335	380
500	320	380	430
600	355	420	475
700	385	460	520
750	400	475	535
800	410	490	555
900	435	520	585
1000	455	545	615
1250	495	590	665
1500	520	625	705
1750	545	650	735
2000	560	665	750

Motor and Drive Basics

Allowable Ampacities of Not More Than Three Insulated Conductors

AWG kcmil	Temperature Rating of Aluminum or Copper-Clad Conductor		
	60°C (140°F) Types TW†, UF†	75°C (167°F) Types RH†, RHW†, THHW†, THW†, THWN†, XHHW†, USE†	90°C (194°F) Types TA, TBS, SA, SIS, THHN†, THHW†, THW-2, THWN-2, RHH†, RHW-S, USE-2, XHH, XHHW, XHHW-2, ZW-2
12	20†	20†	25†
10	25	30†	35†
8	30	40	45
6	40	50	60
4	55	65	75
3	65	75	85
2	75	90	100
1	85	100	115
1/0	100	120	135
2/0	115	135	150
3/0	130	155	175
4/0	150	180	205
250	170	205	230
300	190	230	255
350	210	250	280
400	225	270	305
500	260	310	350
600	285	340	385
700	310	375	420
750	320	385	435
800	330	395	450
900	355	425	480
1000	375	445	500
1250	405	485	545
1500	435	520	585
1750	455	545	615
2000	470	560	630

†Unless otherwise specifically permitted elsewhere in this Code, the overcurrent protection for conductor types marked with an obelisk (†) shall not exceed 15 amperes for No. 14, 20 amperes for No. 12, and 30 amperes for No. 10 copper, or 15 amperes for No. 12 and 25 amperes for No. 10 aluminum and copper-clad aluminum after any correction factors for ambient temperature and number of conductors have been applied.

Adapted from NFPA 70-1993, National Electrical Code®, Copyright 1992.

Motor and Drive Basics

Belt Drives

Most fan drive systems are based on the standard "V" drive belt which is relatively efficient and readily available. The use of a belt drive allows fan RPM to be easily selected through a combination of AC motor RPM and drive pulley ratios.

In general select a sheave combination that will result in the correct drive ratio with the smallest sheave pitch diameters. Depending upon belt cross section, there may be some minimum pitch diameter considerations. Multiple belts and sheave grooves may be required to meet horsepower requirements.

$$\text{Drive Ratio} = \frac{\text{Motor RPM}}{\text{desired fan RPM}}$$

V-belt Length Formula

Once a sheave combination is selected we can calculate approximate belt length. Calculate the approximate V-belt length using the following formula:

$$L = 2C + 1.57(D+d) + \frac{(D-d)^2}{4C}$$

L = Pitch Length of Belt
C = Center Distance of Sheaves
D = Pitch Diameter of Large Sheave
d = Pitch Diameter of Small Sheave

Belt Drive Guidelines

1. Drives should always be installed with provision for center distance adjustment.
2. If possible centers should not exceed 3 times the sum of the sheave diameters nor be less than the diameter of the large sheave.
3. If possible the arc of contact of the belt on the smaller sheave should not be less than 120°.
4. Be sure that shafts are parallel and sheaves are in proper alignment. Check after first eight hours of operation.
5. Do not drive sheaves on or off shafts. Be sure shaft and keyway are smooth and that bore and key are of correct size.
6. Belts should never be forced or rolled over sheaves. More belts are broken from this cause than from actual failure in service.
7. In general, ideal belt tension is the lowest tension at which the belt will not slip under peak load conditions. Check belt tension frequently during the first 24-48 hours of operation.

Motor and Drive Basics

Estimated Belt Drive Loss†

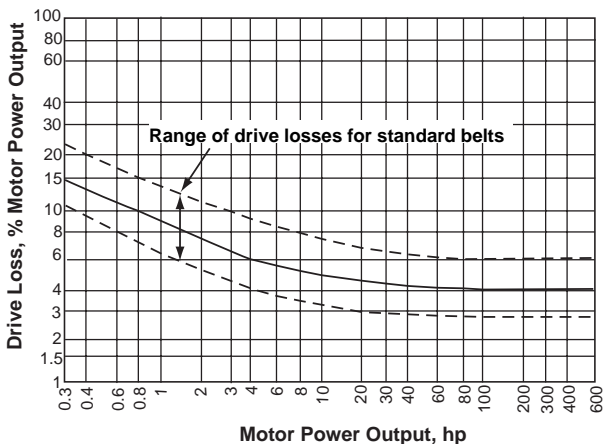

Higher belt speeds tend to have higher losses than lower belt speeds at the same horsepower.

Drive losses are based on the conventional V-belt which has been the “work horse” of the drive industry for several decades.

Example:

- Motor power output is determined to be 13.3 hp.
- The belts are the standard type and just warm to the touch immediately after shutdown.
- From the chart above, the drive loss = 5.1%
- Drive loss = $0.051 \times 13.3 = 0.7$ hp
- Fan power input = $13.3 - 0.7 = 12.6$ hp

† Adapted from AMCA Publication 203-90.

Bearing Life

Bearing life is determined in accordance with methods prescribed in ISO 281/1-1989 or the Anti Friction Bearing Manufacturers Association (AFBMA) Standards 9 and 11, modified to follow the ISO standard. The life of a rolling element bearing is defined as the number of operating hours at a given load and speed the bearing is capable of enduring before the first signs of failure start to occur. Since seemingly identical bearings under identical operating conditions will fail at different times, life is specified in both hours and the statistical probability that a certain percentage of bearings can be expected to fail within that time period.

Example:

A manufacturer specifies that the bearings supplied in a particular fan have a minimum life of L-10 in excess of 40,000 hours at maximum cataloged operating speed. We can interpret this specification to mean that a minimum of 90% of the bearings in this application can be expected to have a life of at least 40,000 hours or longer. *To say it another way, we should expect less than 10% of the bearings in this application to fail within 40,000 hours.*

L-50 is the term given to Average Life and is simply equal to 5 times the Minimum Life. For example, the bearing specified above has a life of L-50 in excess of 200,000 hours. *At least 50% of the bearings in this application would be expected to have a life of 200,000 hours or longer.*

System Design Guidelines

General Ventilation

- Locate intake and exhaust fans to make use of prevailing winds.
- Locate fans and intake ventilators for maximum sweeping effect over the working area.
- If filters are used on gravity intake, size intake ventilator to keep intake losses below 1/8" SP.
- Avoid fans blowing opposite each other, When necessary, separate by at least 6 fan diameters.
- Use Class B insulated motors where ambient temperatures are expected to be high for air-over motor conditions.
- If air moving over motors contains hazardous chemicals or particles, use explosion-proof motors mounted in or out of the airstream, depending on job requirements.
- For hazardous atmosphere applications use fans of non-sparking construction.*

Process Ventilation

- Collect fumes and heat as near the source of generation as possible.
- Make all runs of ducts as short and direct as possible.
- Keep duct velocity as low as practical considering capture for fumes or particles being collected.
- When turns are required in the duct system use long radius elbows to keep the resistance to a minimum (preferably 2 duct diameters).
- After calculating duct resistance, select the fan having reserve capacity beyond the static pressure determined.
- Use same rationale regarding intake ventilators and motors as in General Ventilation guidelines above.
- Install the exhaust fan at a location to eliminate any recirculation into other parts of the plant.
- When hoods are used, they should be sufficient to collect all contaminating fumes or particles created by the process.

*Refer to AMCA Standard 99; See page 4.

Kitchen Ventilation

Hoods and Ducts

- Duct velocity should be between 1500 and 4000 fpm
- Hood velocities (not less than 50 fpm over face area between hood and cooking surface)
 - Wall Type - 80 CFM/ft²
 - Island Type - 125 CFM/ft²
- Extend hood beyond cook surface 0.4 x distance between hood and cooking surface

Filters

- Select filter velocity between 100 - 400 fpm
- Determine number of filters required from a manufacturer's data (usually 2 cfm exhaust for each sq. in. of filter area maximum)
- Install at 45 - 60° to horizontal, never horizontal
- Shield filters from direct radiant heat
- Filter mounting height:
 - No exposed cooking flame—1-1/2' minimum to filter
 - Charcoal and similar fires—4' minimum to filter
- Provide removable grease drip pan
- Establish a schedule for cleaning drip pan and filters and follow it diligently

Fans

- Use upblast discharge fan
- Select design CFM based on hood design and duct velocity
- Select SP based on design CFM and resistance of filters and duct system
- Adjust fan specification for expected exhaust air temperature

System Design Guidelines

Sound

Sound Power (W) - the amount of power a source converts to sound in watts.

Sound Power Level (LW) - a logarithmic comparison of sound power output by a source to a reference sound source, W_0 (10^{-12} watt).

$$L_W = 10 \log_{10} (W/W_0) \text{ dB}$$

Sound Pressure (P) - pressure associated with sound output from a source. Sound pressure is what the human ear reacts to.

Sound Pressure Level (Lp) - a logarithmic comparison of sound pressure output by a source to a reference sound source, P_0 (2×10^{-5} Pa).

$$L_p = 20 \log_{10} (P/P_0) \text{ dB}$$

Even though sound power level and sound pressure level are both expressed in dB, ***THERE IS NO OUTRIGHT CONVERSION BETWEEN SOUND POWER LEVEL AND SOUND PRESSURE LEVEL.*** A constant sound power output will result in significantly different sound pressures and sound pressure levels when the source is placed in different environments.

Rules of Thumb

When specifying sound criteria for HVAC equipment, refer to sound power level, not sound pressure level.

When comparing sound power levels, remember the lowest and highest octave bands are only accurate to about +/-4 dB.

Lower frequencies are the most difficult to attenuate.

2 x sound pressure (single source) = +3 dB(sound pressure level)

2 x distance from sound source = -6dB (sound pressure level)

+10 dB(sound pressure level)= 2 x original loudness perception

When trying to calculate the additive effect of two sound sources, use the approximation (logarithms cannot be added directly) on the next page.

System Design Guidelines

Rules of Thumb (cont.)

Difference between sound pressure levels	dB to add to highest sound pressure level
0	3.0
1	2.5
2	2.1
3	1.8
4	1.5
5	1.2
6	1.0
7	0.8
8	0.6
9	0.5
10+	0

Noise Criteria

Graph sound pressure level for each octave band on NC curve. Highest curve intercepted is NC level of sound source. See *Noise Criteria Curves.*, page 34.

Sound Power and Sound Power Level

Sound Power (Watts)	Sound Power Level dB	Source
25 to 40,000,000	195	Shuttle Booster rocket
100,000	170	Jet engine with afterburner
10,000	160	Jet aircraft at takeoff
1,000	150	Turboprop at takeoff
100	140	Prop aircraft at takeoff
10	130	Loud rock band
1	120	Small aircraft engine
0.1	110	Blaring radio
0.01	100	Car at highway speed
0.001	90	Axial ventilating fan (2500 m ³ h) Voice shouting
0.0001	80	Garbage disposal unit
0.00001	70	Voice—conversational level
0.000001	60	Electronic equipment cooling fan
0.0000001	50	Office air diffuser
0.00000001	40	Small electric clock
0.000000001	30	Voice - very soft whisper

System Design Guidelines

Sound Pressure and Sound Pressure Level

Sound Pressure (Pascals)	Sound Pressure Level dB	Typical Environment
200.0	140	30m from military aircraft at take-off
63.0	130	Pneumatic chipping and riveting (operator's position)
20.0	120	Passenger Jet takeoff at 100 ft.
6.3	110	Automatic punch press (operator's position)
2.0	100	Automatic lathe shop
0.63	90	Construction site—pneumatic drilling
0.2	80	Computer printout room
0.063	70	Loud radio (in average domestic room)
0.02	60	Restaurant
0.0063	50	Conversational speech at 1m
0.002	40	Whispered conversation at 2m
0.00063	30	
0.0002	20	Background in TV recording studios
0.00002	0	Normal threshold of hearing

Room Sones —dBA Correlation†

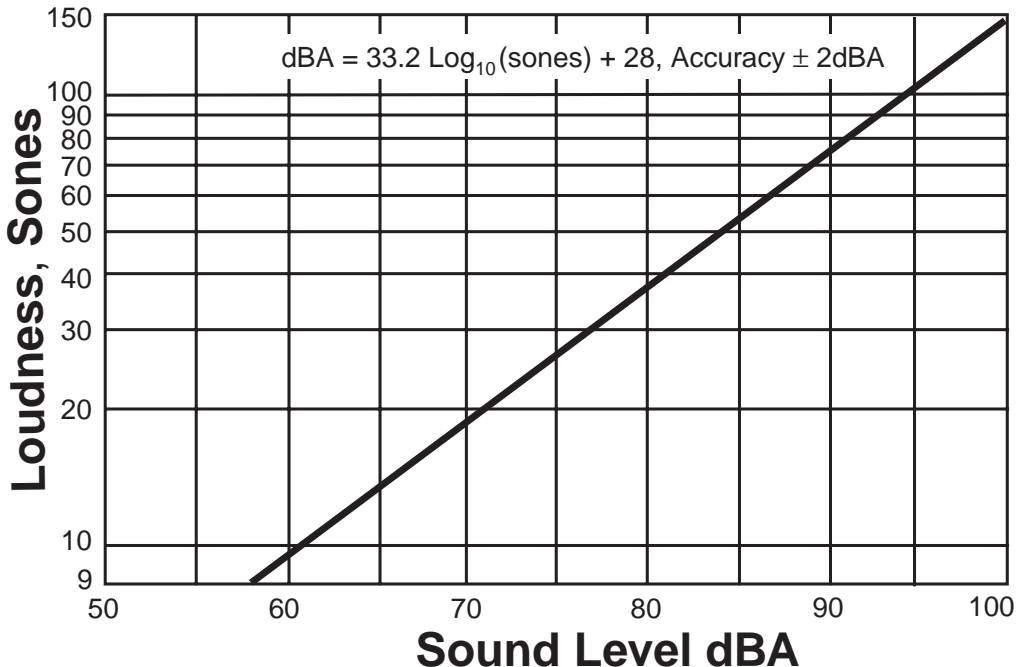

† From ASHRAE 1972 Handbook of Fundamentals

System Design Guidelines

Noise Criteria Curves

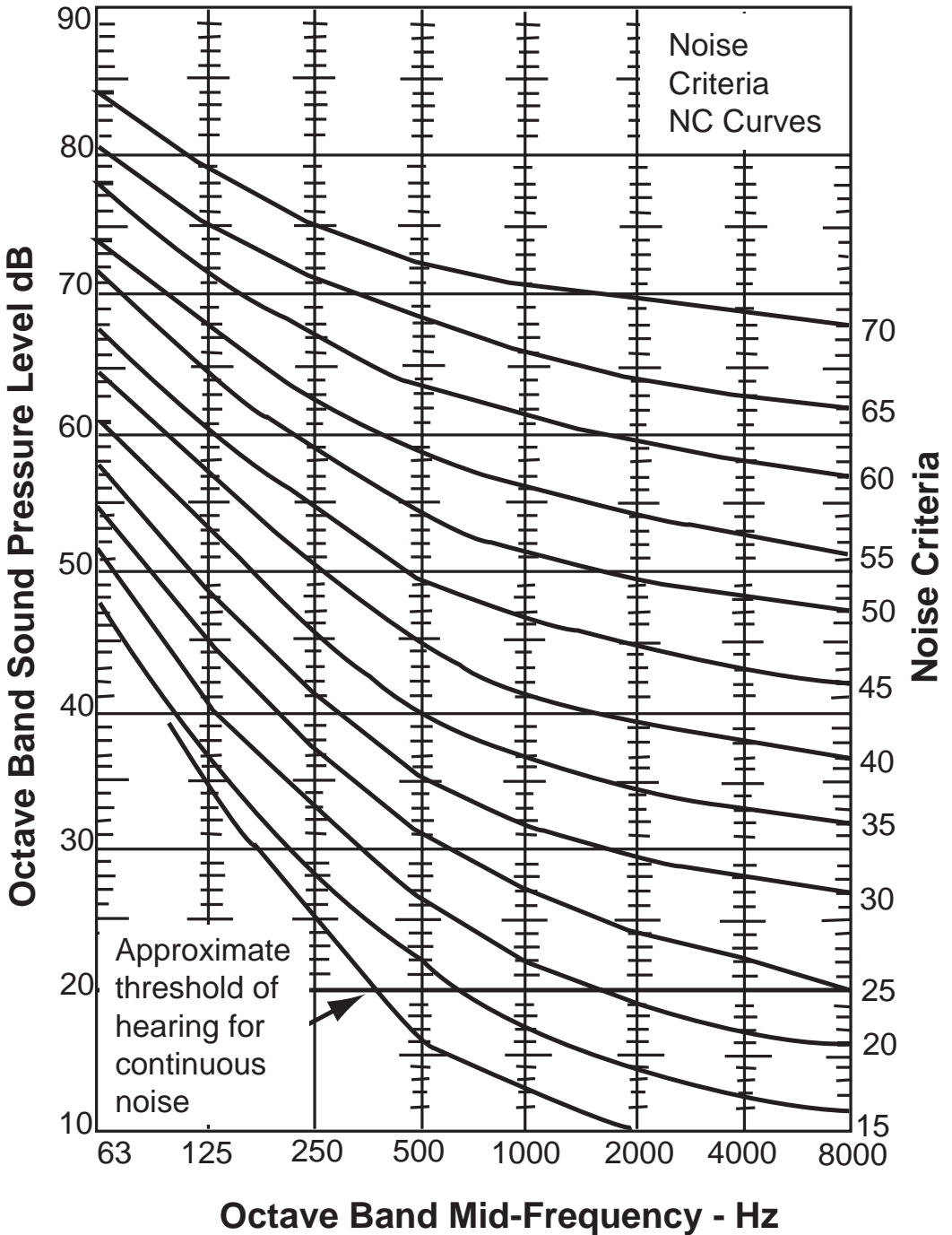

System Design Guidelines

Design Criteria for Room Loudness

Room Type	Sones	Room Type	Sones
Auditoriums		Indoor sports activities	
Concert and opera halls	1.0 to 3	Gymnasiums	4 to 12
Stage theaters	1.5 to 5	Coliseums	3 to 9
Movie theaters	2.0 to 6	Swimming pools	7 to 21
Semi-outdoor amphitheaters	2.0 to 6	Bowling alleys	4 to 12
Lecture halls	2.0 to 6	Gambling casinos	4 to 12
Multi-purpose	1.5 to 5	Manufacturing areas	
Courtrooms	3.0 to 9	Heavy machinery	25 to 60
Auditorium lobbies	4.0 to 12	Foundries	20 to 60
TV audience studios	2.0 to 6	Light machinery	12 to 36
Churches and schools		Assembly lines	12 to 36
Sanctuaries	1.7 to 5	Machine shops	15 to 50
Schools & classrooms	2.5 to 8	Plating shops	20 to 50
Recreation halls	4.0 to 12	Punch press shops	50 to 60
Kitchens	6.0 to 18	Tool maintenance	7 to 21
Libraries	2.0 to 6	Foreman's office	5 to 15
Laboratories	4.0 to 12	General storage	10 to 30
Corridors and halls	5.0 to 15	Offices	
Hospitals and clinics		Executive	2 to 6
Private rooms	1.7 to 5	Supervisor	3 to 9
Wards	2.5 to 8	General open offices	4 to 12
Laboratories	4.0 to 12	Tabulation/computation	6 to 18
Operating rooms	2.5 to 8	Drafting	4 to 12
Lobbies & waiting rooms	4.0 to 12	Professional offices	3 to 9
Halls and corridors	4.0 to 12	Conference rooms	1.7 to 5
		Board of Directors	1 to 3
		Halls and corridors	5 to 15

Note: Values shown above are room loudness in sones and are not fan sone ratings. For additional detail see AMCA publication 302 - Application of Sone Rating.

System Design Guidelines

Design Criteria for Room Loudness (cont.)

Room Type	Sones	Room Type	Sones
Hotels		Public buildings	
Lobbies	4.0 to 12	Museums	3 to 9
Banquet rooms	8.0 to 24	Planetariums	2 to 6
Ball rooms	3.0 to 9	Post offices	4 to 12
Individual rooms/suites	2.0 to 6	Courthouses	4 to 12
Kitchens and laundries	7.0 to 12	Public libraries	2 to 6
Halls and corridors	4.0 to 12	Banks	4 to 12
Garages	6.0 to 18	Lobbies and corridors	4 to 12
Residences		Retail stores	
Two & three family units	3 to 9	Supermarkets	7 to 21
Apartment houses	3 to 9	Department stores (main floor)	6 to 18
Private homes (urban)	3 to 9	Department stores (upper floor)	4 to 12
Private homes (rural & suburban)	1.3 to 4	Small retail stores	6 to 18
Restaurants		Clothing stores	4 to 12
Restaurants	4 to 12	Transportation (rail, bus, plane)	
Cafeterias	6 to 8	Waiting rooms	5 to 15
Cocktail lounges	5 to 15	Ticket sales office	4 to 12
Social clubs	3 to 9	Control rooms & towers	6 to 12
Night clubs	4 to 12	Lounges	5 to 15
Banquet room	8 to 24	Retail shops	6 to 18
Miscellaneous			
Reception rooms	3 to 9		
Washrooms and toilets	5 to 15		
Studios for sound reproduction	1 to 3		
Other studios	4 to 12		

Note: Values shown above are room loudness in sones and are not fan sone ratings. For additional detail see AMCA publication 302 - Application of Sone Rating.

System Design Guidelines

Vibration

System Natural Frequency

The natural frequency of a system is the frequency at which the system prefers to vibrate. It can be calculated by the following equation:

$$f_n = 188 (1/d)^{1/2} \text{ (cycles per minute)}$$

The static deflection corresponding to this natural frequency can be calculated by the following equation:

$$d = (188/f_n)^2 \text{ (inches)}$$

By adding vibration isolation, the transmission of vibration can be minimized. A common rule of thumb for selection of vibration isolation is as follows:

Equipment RPM	Static Deflection of Isolation	
	Critical Installation	Non-critical Installation
1200+	1.0 in	0.5 in
600+	1.0 in	1.0 in
400+	2.0 in	1.0 in
300+	3.0 in	2.0 in

Critical installations are upper floor or roof mounted equipment. Non-critical installations are grade level or basement floor.

Always use total weight of equipment when selecting isolation.

Always consider weight distribution of equipment in selection.

System Design Guidelines

Vibration Severity

Use the **Vibration Severity Chart** to determine acceptability of vibration levels measured.

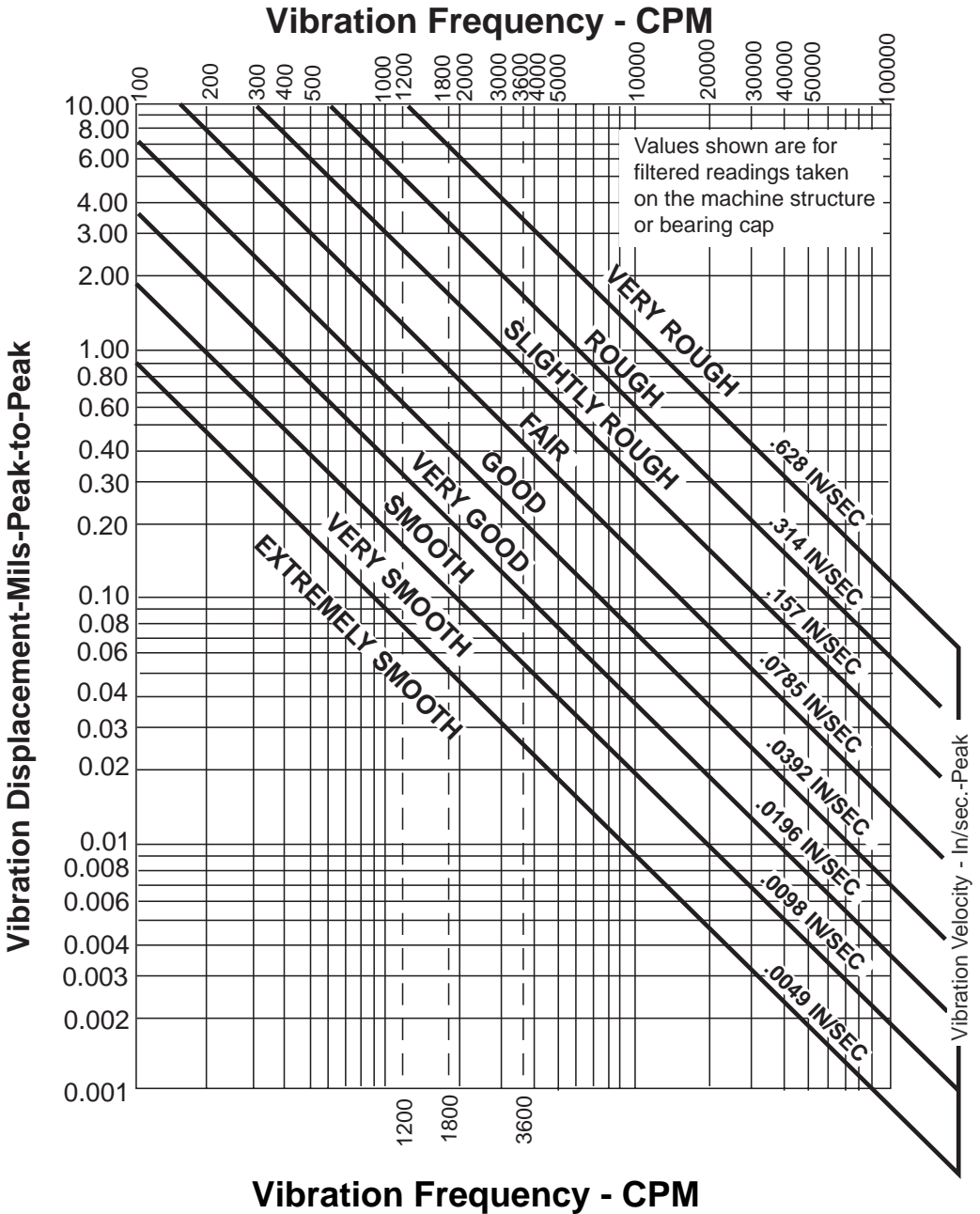

System Design Guidelines

Vibration Severity (cont.)

When using the Machinery Vibration Severity Chart, the following factors must be taken into consideration:

1. When using displacement measurements only filtered displacement readings (for a specific frequency) should be applied to the chart. Unfiltered or overall velocity readings can be applied since the lines which divide the severity regions are, in fact, constant velocity lines.
2. The chart applies only to measurements taken on the bearings or structure of the machine. The chart does not apply to measurements of shaft vibration.
3. The chart applies primarily to machines which are rigidly mounted or bolted to a fairly rigid foundation. Machines mounted on resilient vibration isolators such as coil springs or rubber pads will generally have higher amplitudes of vibration than those rigidly mounted. A general rule is to allow twice as much vibration for a machine mounted on isolators. However, this rule should not be applied to high frequencies of vibration such as those characteristic of gears and defective rolling-element bearings, as the amplitudes measured at these frequencies are less dependent on the method of machine mounting.

General Ventilation Design

Air Quality Method

Designing for acceptable indoor air quality requires that we address:

- Outdoor air quality
- Design of the ventilation systems
- Sources of contaminants
- Proper air filtration
- System operation and maintenance

Determine the number of people occupying the respective building spaces. Find the CFM/person requirements in Ventilation Rates for Acceptable Indoor Air Quality, page 42. Calculate the required outdoor air volume as follows:

$$\text{People} = \text{Occupancy}/1000 \times \text{Floor Area (ft}^2\text{)}$$

$$\text{CFM} = \text{People} \times \text{Outdoor Air Requirement (CFM/person)}$$

Outdoor air quantities can be reduced to lower levels if proper particulate and gaseous air filtration equipment is utilized.

Air Change Method

Find total volume of space to be ventilated. Determine the required number of air changes per hour.

$$\text{CFM} = \text{Bldg. Volume (ft}^3\text{)} / \text{Air Change Frequency}$$

Consult local codes for air change requirements or, in absence of code, refer to “Suggested Air Changes”, page 41.

Heat Removal Method

When the temperature of a space is higher than the ambient outdoor temperature, general ventilation may be utilized to provide “free cooling”. Knowing the desired indoor and the design outdoor dry bulb temperatures, and the amount of heat removal required (BTU/Hr):

$$\text{CFM} = \text{Heat Removal (BTU/Hr)} / (1.10 \times \text{Temp diff})$$

General Ventilation Design

Suggested Air Changes

Type of Space	Air Change Frequency (minutes)
Assembly Halls	3-10
Auditoriums	4-15
Bakeries	1-3
Boiler Rooms	2-4
Bowling Alleys	2-8
Dry Cleaners	1-5
Engine Rooms	1-1.5
Factories (General)	1-5
Forges	1-2
Foundries	1-4
Garages	2-10
Generating Rooms	2-5
Glass Plants	1-2
Gymnasiums	2-10
Heat Treat Rooms	0.5-1
Kitchens	1-3
Laundries	2-5
Locker Rooms	2-5
Machine Shops	3-5
Mills (Paper)	2-3
Mills (Textile)	5-15
Packing Houses	2-15
Recreation Rooms	2-8
Residences	2-5
Restaurants	5-10
Retail Stores	3-10
Shops (General)	3-10
Theaters	3-8
Toilets	2-5
Transformer Rooms	1-5
Turbine Rooms	2-6
Warehouses	2-10

General Ventilation Design

Ventilation Rates for Acceptable Indoor Air Quality†

Space	Outdoor Air Required (CFM/person)	Occupancy (People/1000 ft ²)
Auditoriums	15	150
Ballrooms/Discos	25	100
Bars	30	100
Beauty Shops	25	25
Classrooms	15	50
Conference Rooms	20	50
Correctional Facility Cells	20	20
Dormitory Sleeping Rooms	15	20
Dry Cleaners	30	30
Gambling Casinos	30	120
Game Rooms	25	70
Hardware Stores	15	8
Hospital Operating Rooms	30	20
Hospital Patient Rooms	25	10
Laboratories	20	30
Libraries	15	20
Medical Procedure Rooms	15	20
Office Spaces	20	7
Pharmacies	15	20
Photo Studios	15	10
Physical Therapy	15	20
Restaurant Dining Areas	20	70
Retail Facilities	15	20
Smoking Lounges	60	70
Sporting Spectator Areas	15	150
Supermarkets	15	8
Theaters	15	150

†Adapted from ASHRAE Standard 62-1989 "Ventilation for Acceptable Indoor Air Quality".

General Ventilation Design

Heat Gain From Occupants of Conditioned Spaces¹

Typical Application	Sensible Heat (BTU/HR)*	Latent Heat (BTU/HR)
Theater-Matinee	200	130
Theater-Evening	215	135
Offices, Hotels, Apartments	215	185
Retail and Department Stores	220	230
Drug Store	220	280
Bank	220	280
Restaurant ²	240	310
Factory	240	510
Dance Hall	270	580
Factory	330	670
Bowling Alley ³	510	940
Factory	510	940

Notes:

- ¹ Tabulated values are based on 78°F for dry-bulb temperature.
 - ² Adjusted total heat value for sedentary work, restaurant, includes 60 Btuh for food per individual (30 Btu sensible and 30 Btu latent).
 - ³ For bowling figure one person per alley actually bowling, and all others as sitting (400 Btuh) or standing (55 Btuh).
- * Use sensible values only when calculating ventilation to remove heat.

Adapted from Chapter 26 ASHRAE "Fundamentals" Handbook, 1989.

General Ventilation Design

Heat Gain From Typical Electric Motors†

Motor Name-plate or Rated Horse-power	Motor Type	Nominal rpm	Full Load Motor Efficiency in Percent	Motor In, Driven Equipment in Space Btuh	Motor Out, Driven Equipment in Space Btuh	Motor 2nd Driven Equipment Out of Space Btuh
0.25	Split Ph.	1750	54	1,180	640	540
0.33	Split Ph.	1750	56	1,500	840	660
0.50	Split Ph.	1750	60	2,120	1,270	850
0.75	3-Ph.	1750	72	2,650	1,900	740
1	3-Ph.	1750	75	3,390	2,550	850
1	3-Ph.	1750	77	4,960	3,820	1,140
2	3-Ph.	1750	79	6,440	5,090	1,350
3	3-Ph.	1750	81	9,430	7,640	1,790
5	3-Ph.	1750	82	15,500	12,700	2,790
7.5	3-Ph.	1750	84	22,700	19,100	3,640
10	3-Ph.	1750	85	29,900	24,500	4,490
15	3-Ph.	1750	86	44,400	38,200	6,210
20	3-Ph.	1750	87	58,500	50,900	7,610
25	3-Ph.	1750	88	72,300	63,600	8,680
30	3-Ph.	1750	89	85,700	76,300	9,440
40	3-Ph.	1750	89	114,000	102,000	12,600
50	3-Ph.	1750	89	143,000	127,000	15,700
60	3-Ph.	1750	89	172,000	153,000	18,900
75	3-Ph.	1750	90	212,000	191,000	21,200
100	3-Ph.	1750	90	283,000	255,000	28,300
125	3-Ph.	1750	90	353,000	318,000	35,300
150	3-Ph.	1750	91	420,000	382,000	37,800
200	3-Ph.	1750	91	569,000	509,000	50,300
250	3-Ph.	1750	91	699,000	636,000	62,900

† Adapted from Chapter 26 ASHRAE "Fundamentals" Handbook, 1989.

General Ventilation Design

Rate of Heat Gain From Commercial Cooking Appliances in Air-Conditioned Area†

Appliance Gas-Burning, Floor Mounted Type	Manufacturer's Input Rating		
	Watts	Btuh	Heat gain With Hood
Broiler, unit		70,000	7,000
Deep fat fryer		100,000	6,500
Oven, deck, per sq. ft of hearth area		4,000	400
Oven, roasting		80,000	8,000
Range, heavy duty - Top section		64,000	6,400
Range, heavy duty - Oven		40,000	4,000
Range, jr., heavy duty - Top section		45,000	4,500
Range, jr., heavy duty - Oven		35,000	3,500
Range, restaurant type per 2-burner section		24,000	2,400
per oven		30,000	3,000
per broiler-griddle		35,000	3,500
Electric, Floor Mounted Type			
Griddle	16,800	57,300	2,060
Broiler, no oven	12,000	40,900	6,500
with oven	18,000	61,400	9,800
Broiler, single deck	16,000	54,600	10,800
Fryer	22,000	75,000	730
Oven, baking, per sq. ft of hearth	500	1,700	270
Oven, roasting, per sq. ft of hearth	900	3,070	490
Range, heavy duty - Top section	15,000	51,200	19,100
Range, heavy duty - Oven	6,700	22,900	1,700
Range, medium duty - Top section	8,000	27,300	4,300
Range, medium duty - Oven	3,600	12,300	1,900
Range, light duty - Top section	6,600	22,500	3,600
Range, light duty - Oven	3,000	10,200	1,600

† Adapted from Chapter 26 ASHRAE "Fundamentals" Handbook, 1989

General Ventilation Design

Rate of Heat Gain From Miscellaneous Appliances

Electrical Appliances	Manufacturer's Rating		Recommended Rate of Heat Gain, Btuh		
	Watts	Btuh	*Sensible	Latent	Total
Hair dryer	1,580	5,400	2,300	400	2,700
Hair dryer	705	2,400	1,870	330	2,200
Neon sign,			30		30
per linear ft of tube			60		60
Sterilizer, instrument	1,100	3,750	650	1,200	1,850
Gas-Burning Appliances					
Lab burners		3,000	1,680	420	2,100
Bunsen					
Fishtail		5,000	2,800	700	3,500
Meeker		6,000	3,360	840	4,200
Gas Light, per burner		2,000	1,800	200	2,000
Cigar lighter		2,500	900	100	1,000

Adapted from Chapter 26 ASHRAE "Fundamentals" Handbook, 1989.

**Use sensible heat gain for ventilation calculation.*

Filter Comparison

Filter Type	ASHRAE Arrestance Efficiency	ASHRAE Atmospheric Dust Spot Efficiency	Initial Pressure Drop (IN.WG)	Final Pressure Drop (IN.WG)
Permanent	60-80%	8-12%	0.07	.5
Fiberglass Pad	70-85%	15-20%	0.17	.5
Polyester Pad	82-90%	15-20%	0.20	.5
2" Throw Away	70-85%	15-20%	0.17	.5
2" Pleated Media	88-92%	25-30%	0.25	.5-.8
60% Cartridge	97%	60-65%	0.3	1.0
80% Cartridge	98%	80-85%	0.4	1.0
90% Cartridge	99%	90-95%	0.5	1.0
HEPA	100%	99.97%	1.0	2.0

General Ventilation Design

Optimum Relative Humidity Ranges for Health

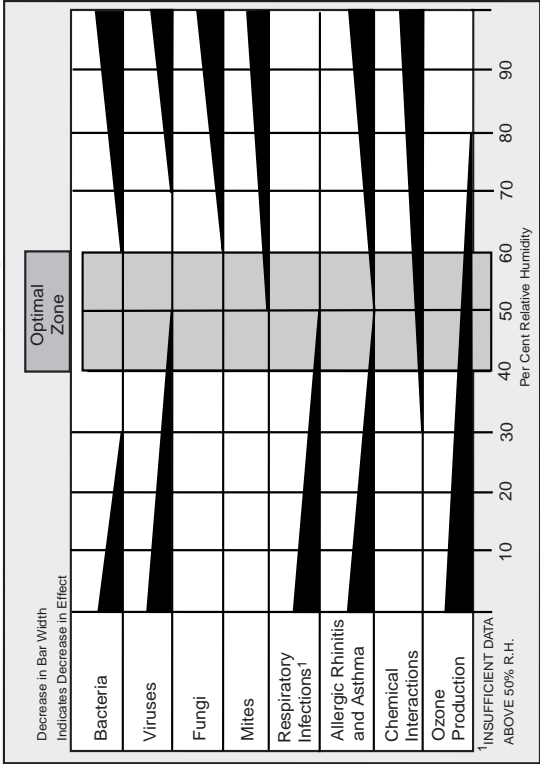

Optimum relative humidity ranges for health as found by E.M. Sterling in "Criteria for Human Exposure to Humidity in Occupied Buildings." ASHRAE Winter Meeting, 1985.

Duct Design

Damper Pressure Drop

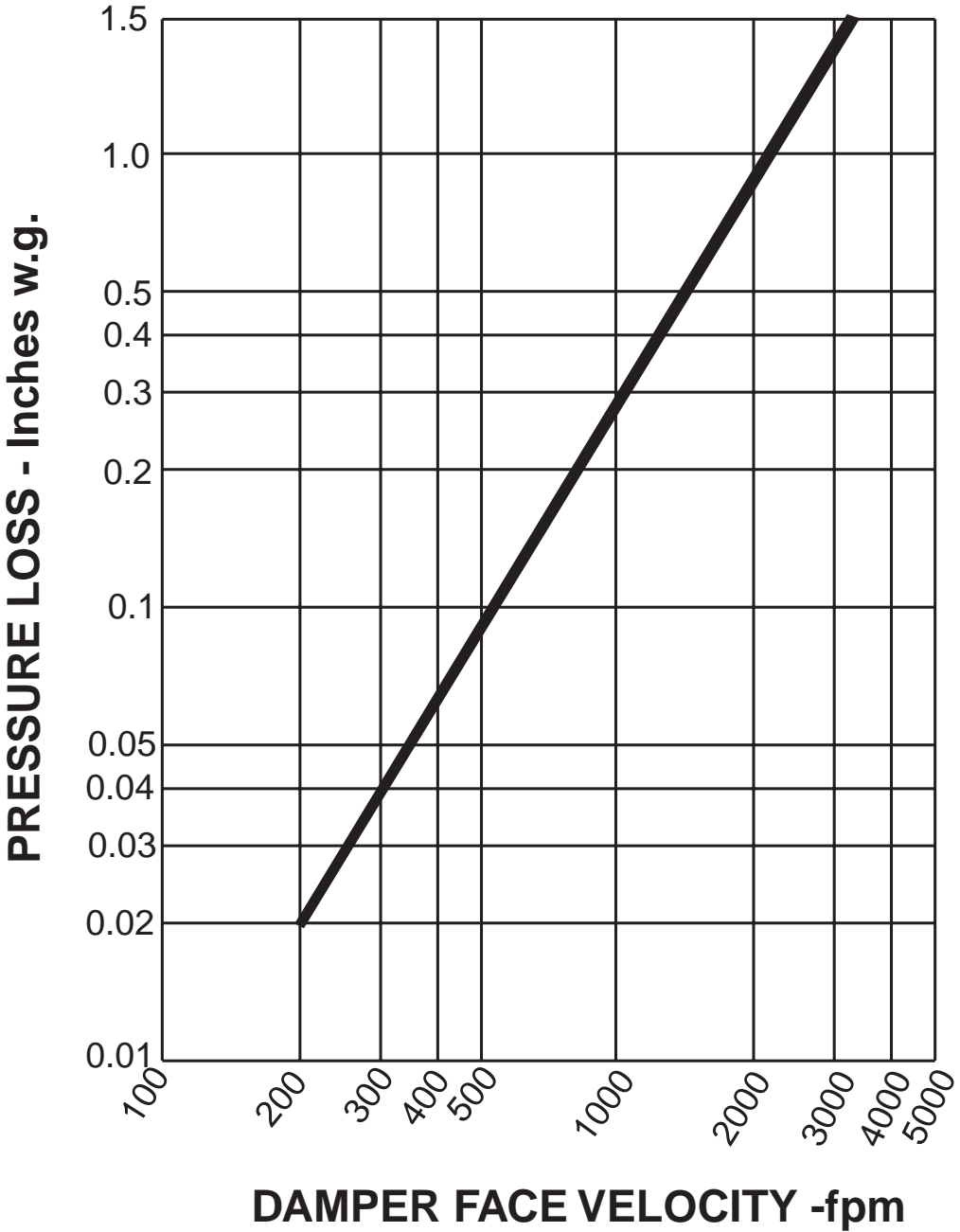

$$V \text{ (Velocity)} = \frac{\text{CFM}}{\text{Sq. Ft. Damper Area}}$$

Adapted from HVAC Systems Duct Design, Third Edition, 1990, Sheet Metal & Air Conditioning Contractor's National Association.

Screen Pressure Drop

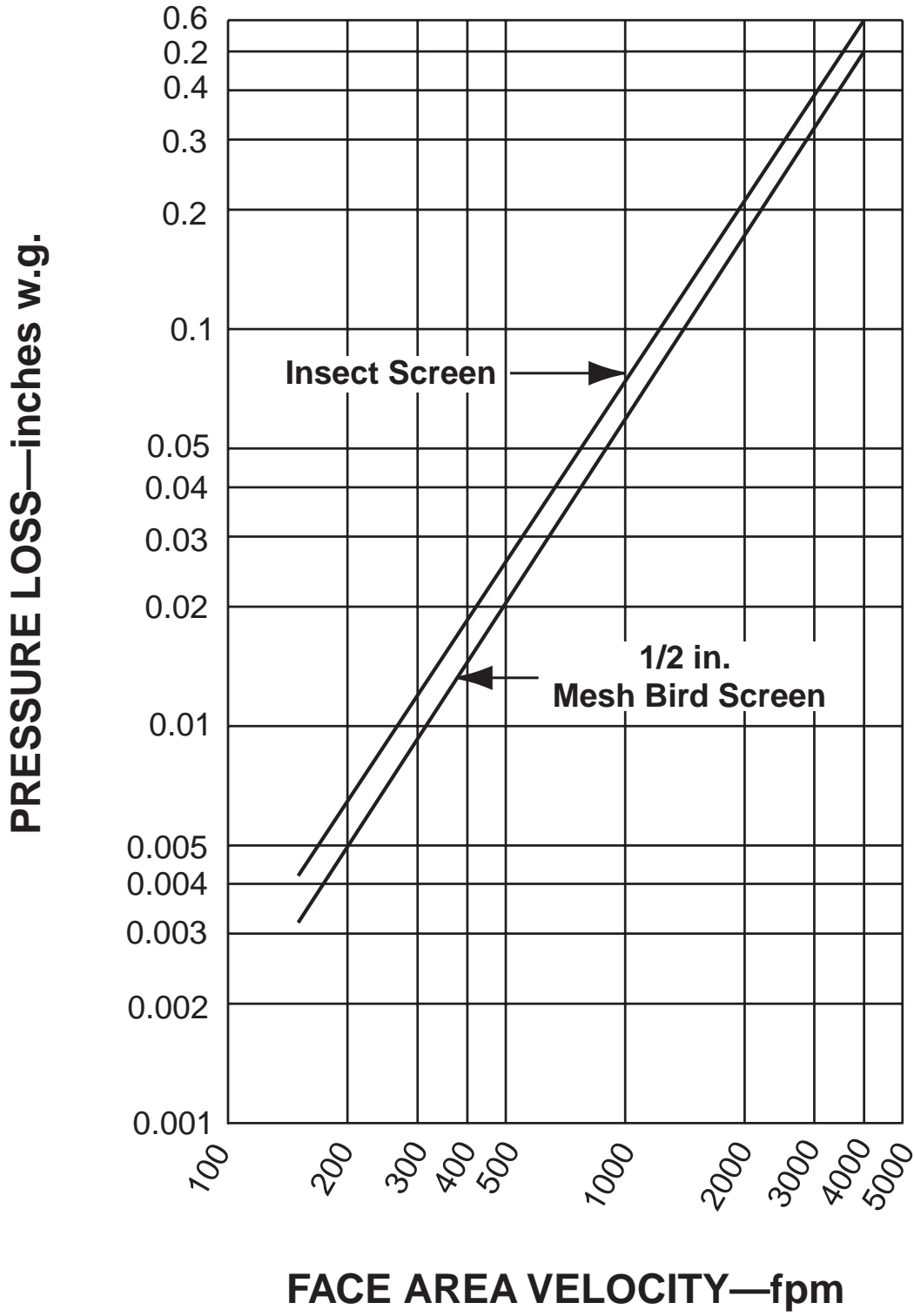

Adapted from HVAC Systems Duct Design, Third Edition, 1990, Sheet Metal & Air Conditioning Contractor's National Association.

Duct Design

Duct Resistance

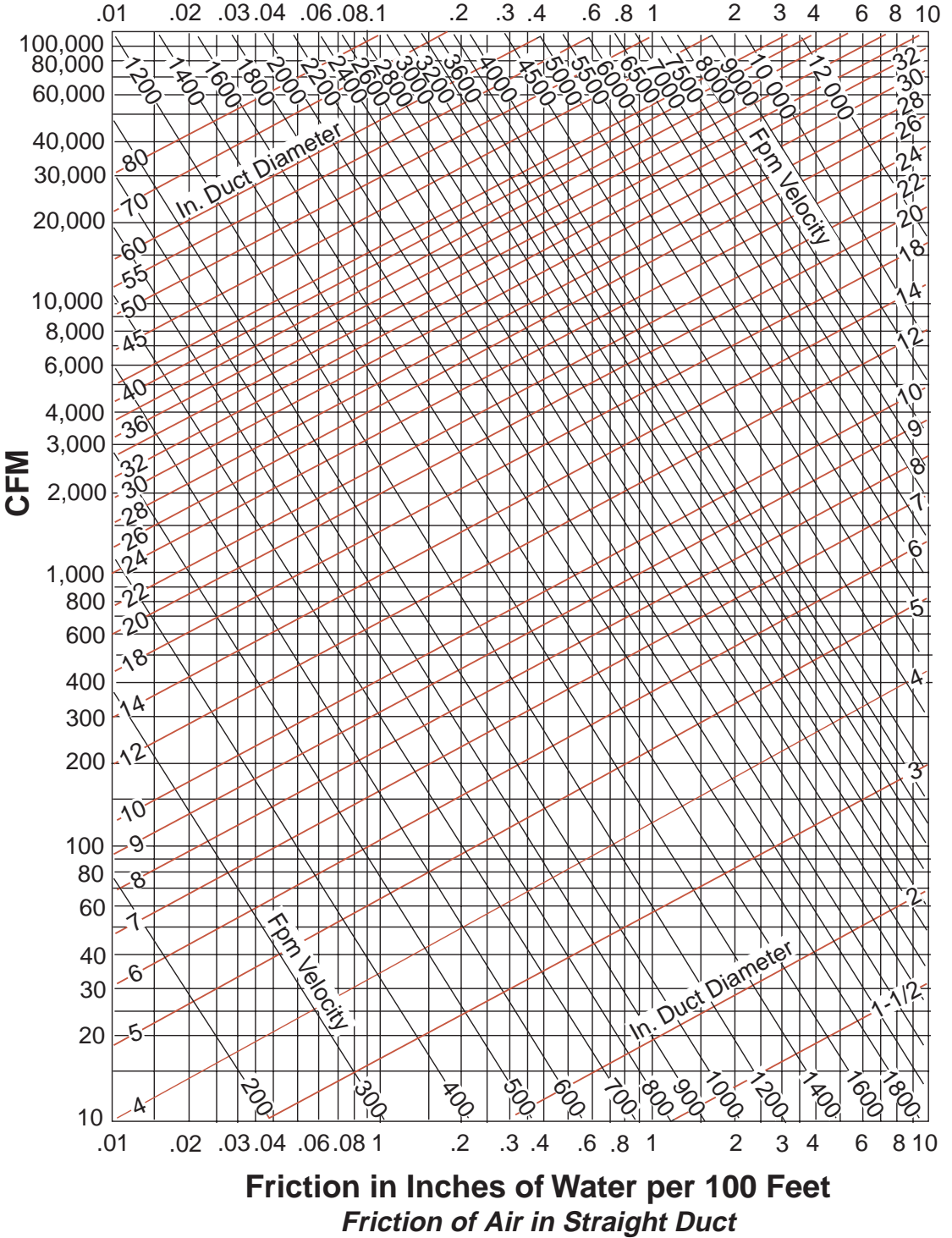

Rectangular Equivalent of Round Ducts

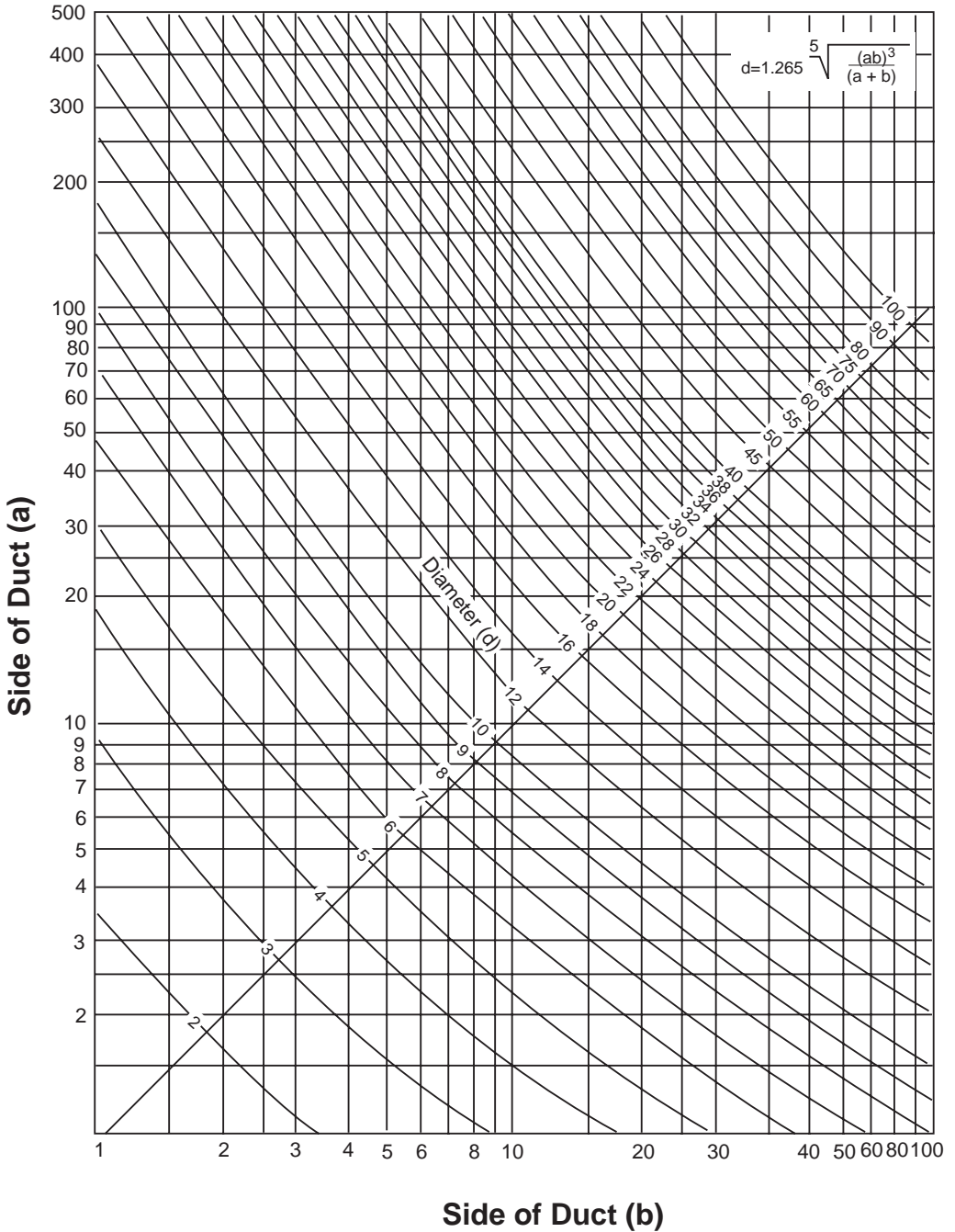

Duct Design

Typical Design Velocities for HVAC Components*

	Velocity (FPM)
Intake Louvers	
• 7000 cfm and greater	400
Exhaust Louvers	
• 5000 cfm and greater	500
Panel Filters	
• Viscous Impingement	200 to 800
• Dry-Type, Pleated Media:	
• Low Efficiency	350
• Medium Efficiency	500
• High Efficiency	500
• HEPA	250
Renewable Media Filters	
• Moving-Curtain Viscous Impingement	500
• Moving-Curtain Dry-Media	200
Electronic Air Cleaners	
• Ionizing-Plate-Type	300 to 500
• Charged-Media Non-ionizing	250
• Charged-Media Ionizing	150 to 350
	500 to 600
Steam and Hot Water Coils	200 min. 1500 max
Electric Coils	
• Open Wire	Refer to Mfg. Data
• Finned Tubular	Refer to Mfg. Data
Dehumidifying Coils	500 to 600
Spray-Type Air Washers	300 to 600
Cell-Type Air Washers	Refer to Mfg. Data
High-Velocity, Spray-Type Air Washers	1200 to 1800

* Adapted from ASHRAE "Pocket Guide", 1993

Velocity and Velocity Pressure Relationships

Velocity (fpm)	Velocity Pressure (in wg)	Velocity (fpm)	Velocity Pressure (in wg)
300	0.0056	3500	0.7637
400	0.0097	3600	0.8079
500	0.0155	3700	0.8534
600	0.0224	3800	0.9002
700	0.0305	3900	0.9482
800	0.0399	4000	0.9975
900	0.0504	4100	1.0480
1000	0.0623	4200	1.0997
1100	0.0754	4300	1.1527
1200	0.0897	4400	1.2069
1300	0.1053	4500	1.2624
1400	0.1221	4600	1.3191
1500	0.1402	4700	1.3771
1600	0.1596	4800	1.4364
1700	0.1801	4900	1.4968
1800	0.2019	5000	1.5586
1900	0.2250	5100	1.6215
2000	0.2493	5200	1.6857
2100	0.2749	5300	1.7512
2200	0.3017	5400	1.8179
2300	0.3297	5500	1.8859
2400	0.3591	5600	1.9551
2500	0.3896	5700	2.0256
2600	0.4214	5800	2.0972
2700	0.4544	5900	2.1701
2800	0.4887	6000	2.2443
2900	0.5243	6100	2.3198
3000	0.5610	6200	2.3965
3100	0.5991	6300	2.4744
3200	0.6384	6400	2.5536
3300	0.6789	6500	2.6340
3400	0.7206	6600	2.7157

For calculation of velocity pressures at velocities other than those listed above: $P_v = (V/4005)^2$

For calculation of velocities when velocity pressures are known:

$$V=4005 \sqrt{(V_p)}$$

Duct Design

U.S. Sheet Metal Gauges

Gauge No.	Steel (Manuf. Std. Ga.)		Galvanized (Manuf. Std. Ga.)	
	Thick. in.	Lb./ft. ²	Thick.in.	Lb./ft. ²
26	.0179	.750	.0217	.906
24	.0239	1.00	.0276	1.156
22	.0299	1.25	.0336	1.406
20	.0359	1.50	.0396	1.656
18	.0478	2.00	.0516	2.156
16	.0598	2.50	.0635	2.656
14	.0747	3.125	.0785	3.281
12	.1046	4.375	.1084	4.531
10	.1345	5.625	.1382	5.781
8	.1644	6.875	.1681	7.031
7	.1793	7.50	—	—

Gauge No.	Mill Std. Thick Aluminum*		Stainless Steel (U.S. Standard Gauge)	
	Thick. in.	Lb./ft. ²	Thick.in.	Lb./ft. ²
26	.020	.282	.0188	.7875
24	.025	.353	.0250	1.050
22	.032	.452	.0312	1.313
20	.040	.564	.0375	1.575
18	.050	.706	.050	2.100
16	.064	.889	.062	2.625
14	.080	1.13	.078	3.281
12	.100	1.41	.109	4.594
10	.125	1.76	.141	5.906
8	.160	2.26	.172	7.218
7	.190	2.68	.188	7.752

*Aluminum is specified and purchased by material thickness rather than gauge.

Recommended Metal Gauges for Duct

Rectangular Duct			Round Duct		
Greatest Dimension	U.S. ga.	B&S ga.	Diameter	Galv. Steel U.S. ga.	Aluminum B&S ga.
to 30 in.	24	22	to 8 in.	24	22
31-60	22	20	9-24	22	20
61-90	20	18	25-48	20	18
91-up	18	16	49-72	18	16

Wind Driven Rain Louvers†

A new category of product has emerged recently called a wind-driven rain louver. These are architectural louvers designed to reject moisture that are tested and evaluated under simulated wind driven rain conditions. Since these are relatively new products, several different test standards have emerged to evaluate the performance of these products under severe wind and rain weather conditions. In addition, manufacturers have developed their own standards to help evaluate the rain resistance of their products. Specifying engineers should become familiar with the differences in various rain and pressure drop test standards to correctly evaluate each manufacturer's claims. Four test standards are detailed below:

	Dade Co. Test	Power Plant Test	AMCA 500 Test*	HEVAC Test
Wind Velocity m/s (mph)	16-50 (35 - 110)	22 (50)	0	13.5 (30)
Rain Fall Rate mm/h (in./h)	220 (8.8)	38-280 (1.5 to 10.9)	100 (4)	75 (3)
Wet Wall Water Flow Rate L/s (gpm)	0	0	0.08 (1.25)	0
Airflow Through Louder m/s (fpm)	0	6.35 (1,250) Free Area Velocity	6.35 (1,250) Free Area Velocity	3.6 (700) Free Core Area Velocity

†Table from AMCA Supplement to ASHRAE Journal, September 1998.

*AMCA Louver Engineering Committee at this writing is currently updating AMCA 500-L to allow testing of varying sizes, wind speed, and rainfall intensity and is developing a Certified Ratings Program for this product category.

Heating & Refrigeration

Moisture and Air Relationships

ASHRAE has adopted pounds of moisture per pound of dry air as standard nomenclature. Relations of other units are expressed below at various dewpoint temperatures.

Equiv. Dew Pt., °F	Lb H ₂ O/lb dry air	Parts per million	Grains/lb dry air ^a	Percent Moisture % ^b
-100	0.000001	1	0.0007	—
-90	0.000002	2	0.0016	—
-80	0.000005	5	0.0035	—
-70	0.00001	10	0.073	0.06
-60	0.00002	21	0.148	0.13
-50	0.00004	42	0.291	0.26
-40	0.00008	79	0.555	0.5
-30	0.00015	146	1.02	0.9
-20	0.00026	263	1.84	1.7
-10	0.00046	461	3.22	2.9
0	0.0008	787	5.51	5.0
10	0.0013	1,315	9.20	8.3
20	0.0022	2,152	15.1	13.6
30	0.0032	3,154	24.2	21.8
40	0.0052	5,213	36.5	33.0
50	0.0077	7,658	53.6	48.4
60	0.0111	11,080	77.6	70.2
70	0.0158	15,820	110.7	100.0
80	0.0223	22,330	156.3	—
90	0.0312	31,180	218.3	—
100	0.0432	43,190	302.3	—

^a7000 grains = 1 lb

^bCompared to 70°F saturated

Normally the sensible heat factor determines the cfm required to accept a load. In some industrial applications the latent heat factor may control the air circulation rate.

$$\text{Thus cfm} = \frac{\text{Latent heat}_1 \text{ Btu/h}}{(W_1 - W_2) \times 4840}$$

Adapted from "Numbers," by Bill Hollady & Cy Otterholm 1985.

Heating & Refrigeration

Properties of Saturated Steam†

Temperature °F	Pressure PSIA	Specific Volume	Specific Enthalpy	
		Sat. Vapor Ft ³ /lbm	Sat. Liquid Btu/lbm	Sat. Vapor Btu/lbm
32	0.08859	3304.7	-0.0179	1075.5
40	0.12163	2445.8	8.027	1079.0
60	0.25611	1207.6	28.060	1087.7
80	0.50683	633.3	48.037	1096.4
100	0.94924	350.4	67.999	1105.1
120	1.6927	203.26	87.97	1113.6
140	2.8892	123.00	107.95	1122.0
160	4.7414	77.29	127.96	1130.2
180	7.5110	50.22	148.00	1138.2
200	11.526	33.639	168.09	1146.0
212	14.696	26.799	180.17	1150.5
220	17.186	23.148	188.23	1153.4
240	24.968	16.321	208.45	1160.6
260	35.427	11.762	228.76	1167.4
280	49.200	8.644	249.17	1173.8
300	67.005	6.4658	269.7	1179.7
320	89.643	4.9138	290.4	1185.2
340	117.992	3.7878	311.3	1190.1
360	153.010	2.9573	332.3	1194.4
380	195.729	2.3353	353.6	1198.0
400	247.259	1.8630	375.1	1201.0
420	308.780	1.4997	396.9	1203.1
440	381.54	1.21687	419.0	1204.4
460	466.87	0.99424	441.5	1204.8
480	566.15	0.81717	464.5	1204.1
500	680.86	0.67492	487.9	1202.2
520	812.53	0.55957	512.0	1199.0
540	962.79	0.46513	536.8	1194.3
560	1133.38	0.38714	562.4	1187.7
580	1326.17	0.32216	589.1	1179.0
600	1543.2	0.26747	617.1	1167.7
620	1786.9	0.22081	646.9	1153.2
640	2059.9	0.18021	679.1	1133.7
660	2365.7	0.14431	714.9	1107.0
680	2708.6	0.11117	758.5	1068.5
700	3094.3	0.07519	822.4	995.2
705.47	3208.2	0.05078	906.0	906.0

†Based on "1967 ASME Steam Tables"

Heating & Refrigeration

Cooling Load Check Figures

Classification	Occupancy		Lights		Refrigeration		Air Quantities CFM/Sq.Ft.					
	Sq. Ft./Person		Watts/Sq.Ft.		Sq.Ft./Ton†		East-South-West		North		Internal	
	Lo	Hi	Lo	Hi	Lo	Hi	Lo	Hi	Lo	Hi	Lo	Hi
Apartment, High Rise	325	100	1.0	4.0	450	350	0.8	1.7	0.5	1.3	—	—
Auditoriums, Churches, Theaters	15	6	1.0	3.0	400	90	—	—	—	—	1.0	3.0
Educational Facilities Schools, Colleges, Universities	30	20	2.0	6.0	240	150	1.0	2.2	0.9	2.0	0.8	1.9
Factories-Assembly Areas	50	25	3.0†	6.0†	240	90	—	—	—	—	2.0	5.5
Light Manufacturing	200	100	9.0†	12.0†	200	100	—	—	—	—	1.6	3.8
Heavy Manufacturing‡	300	200	15.0†	60.0†	100	60	—	—	—	—	2.5	6.5
Hospitals-Patient Rooms*	75	25	1.0	2.0	275	165	0.33	0.67	0.33	0.67	—	—
Public Areas	100	50	1.0	2.0	175	110	1.0	1.45	1.0	1.2	0.95	1.1
Hotels, Motels, Dormitories	200	100	1.0	3.0	350	220	1.0	1.5	0.9	1.4	—	—
Libraries and Museums	80	40	1.0	3.0	340	200	1.0	2.1	0.9	1.3	0.9	1.1
Office Buildings*	130	80	4.0	9.0†	360	190	0.25	0.9	0.25	0.8	0.8	1.8
Private Offices*	150	100	2.0	8.0	—	—	0.25	0.9	0.25	0.8	—	—
Cubicle Area	100	70	5.0*	10.0*	—	—	—	—	—	—	0.9	2.0
Residential -Large	600	200	1.0	4.0	600	380	0.8	1.6	0.5	1.3	—	—
Medium	600	200	0.7	3.0	700	400	0.7	1.4	0.5	1.2	—	—
Restaurants - Large	17	13	15	2.0	135	80	1.8	3.7	1.2	2.1	0.8	1.4
Medium					150	100	1.5	3.0	1.1	1.8	0.9	1.3

Cooling Load Check Figures (cont.)

Classification	Occupancy Sq. Ft./Person		Lights Watts/Sq.Ft.		Refrigeration Sq. Ft./Ton†		Air Quantities CFM/Sq.Ft.					
	Lo	Hi	Lo	Hi	Lo	Hi	East-South-West		North		Internal	
							Lo	Hi	Lo	Hi	Lo	Hi
Beauty & Barber Shops	45	25	3.0*	9.0*	240	105	1.5	4.2	1.1	2.6	0.9	2.0
Dept. Stores-Baseament	30	20	2.0	4.0	340	225	—	—	—	—	0.7	1.2
Main Floor	45	16	3.5	9.0†	350	150	—	—	—	—	0.9	2.0
Upper Floors	75	40	2.0	3.5†	400	280	—	—	—	—	0.8	1.2
Clothing Stores	50	30	1.0	4.0	345	185	0.9	1.6	0.7	1.4	0.6	1.1
Drug Stores	35	17	1.0	3.0	180	110	1.8	3.0	1.0	1.8	0.7	1.3
Discount Stores	35	15	1.5	5.0	345	120	0.7	2.0	0.6	1.6	0.5	1.1
Shoe Stores	50	20	1.0	3.0	300	150	1.2	2.1	1.0	1.8	0.8	1.2
Malls	100	50	1.0	2.0	365	160	—	—	—	—	1.1	2.5
Refrigeration for Central Heating and Cooling Plant												
Urban Districts						285						
College Campuses						240						
Commercial Centers						200						
Residential Centers						375						

Refrigeration and air quantities for applications listed in this table of cooling load check figures are based on all-air system and normal outdoor air quantities for ventilation except as noted.

Notes: †Refrigeration loads are for entire application.

‡Includes other loads expressed in Watts sq. ft.

◆ Air quantities for heavy manufacturing areas are based on supplementary means to remove excessive heat.

*Air quantities for hospital patient rooms and office buildings (except internal areas) are based on induction (air-water) system.

Heating & Refrigeration

Heat Loss Estimates

The following will give quick estimates of heat requirements in a building knowing the cu.ft. volume of the building and design conditions.

Type of Structure		Masonry Wall			Insulated Steel Wall		
		Indoor Temp (F)					
		60°	65°	70°	60°	65°	70°
		BTU/Cubic Foot			BTU/Cubic Foot		
Single Story 4 Walls Exposed		3.4	3.7	4.0	2.2	2.4	2.6
Single Story One Heated Wall		2.9	3.1	3.4	1.9	2.0	2.2
Single Floor One Heated Wall Heated Space Above		1.9	2.0	2.2	1.3	1.4	1.5
Single Floor Two Heated Walls Heated Space Above		1.4	1.5	1.6	0.9	1.0	1.1
Single Floor Two Heated Walls		2.4	2.6	2.8	1.6	1.7	1.8
Multi-Story	2 Story	2.9	3.1	3.4	1.9	2.1	2.2
	3 Story	2.8	3.0	3.2	1.8	2.0	2.1
	4 Story	2.7	2.9	3.1	—	—	—
	5 Story	2.6	2.8	3.0	—	—	—

The following correction factors must be used and multiplied by the answer obtained above.

Corrections for Outdoor Design		Corrections for "R" Factor (Steel Wall)	
Temperature	Multiplier	"R" Factor	Multiplier
+50	.23	8	1.0
+40	.36	10	.97
+30	.53	12	.95
+20	.69	14	.93
+10	.84	16	.92
+ 0	1.0	19	.91
-10	1.15		
-20	1.2		
-30	1.46		

Heating & Refrigeration

Heat Loss Estimates (cont.)

Considerations Used for Corrected Values

- 1—0°F Outdoor Design (See Corrections)
- 2—Slab Construction—If Basement is involved multiply final BTUH by 1.7.
- 3—Flat Roof
- 4—Window Area is 5% of Wall Area
- 5—Air Change is .5 Per Hour.

Fuel Comparisons**

This provides equivalent BTU Data for Various Fuels.

Natural Gas	1,000,000 BTU = 10 Therms or 1,000,000 BTU = (1000 Cu. Ft.)
Propane Gas	1,000,000 BTU = 46 Lb. or 1,000,000 BTU = 10.88 Gallon
No. 2 Fuel Oil	1,000,000 BTU = 7.14 Gallon
Electrical Resistance	1,000,000 BTU = 293 KW (Kilowatts)
Municipal Steam	1,000,000 BTU = 1000 Lbs. Condensate
Sewage Gas	1,000,000 BTU = 1538 Cu.Ft. to 2380 Cu.Ft.
LP/Air Gas	1,000,000 BTU = 46 Lb. Propane or 1,000,000 BTU = 10.88 Gallon Propane or 1,000,000 BTU = 690 Cu.Ft. Gas/Air Mix

Fuel Gas Characteristics

Natural Gas	925 to 1125 BTU/Cu.Ft.	.6 to .66 Specific Gravity
Propane Gas	2550 BTU/Cu.Ft.	1.52 Specific Gravity
*Sewage Gas	420 to 650 BTU/Cu.Ft.	.55 to .85 Specific Gravity
*Coal Gas	400 to 500 BTU/Cu.Ft.	.5 to .6 Specific Gravity
*LP/Air Mix	1425 BTU/Cu.Ft.	1.29 Specific Gravity

* Before attempting to operate units on these fuels, contact manufacturer.

** Chemical Rubber Publishing Co., Handbook of Chemistry and Physics.

Heating & Refrigeration

Estimated Seasonal Efficiencies of Heating Systems

Systems	Seasonal Efficiency
Gas Fired Gravity Vent Unit Heater	62%
Energy Efficient Unit Heater	80%
Electric Resistance Heating	100%
Steam Boiler with Steam Unit Heaters	65%-80%
Hot Water Boiler with HYD Unit Heaters	65%-80%
Oil Fired Unit Heaters	78%
Municipal Steam System	66%
INFRA Red (High Intensity)	85%
INFRA Red (Low Intensity)	87%
Direct Fired Gas Make Up Air	94%
Improvement with Power Ventilator Added to Gas Fired Gravity Vent Unit Heater	4%
Improvement with Spark Pilot Added to Gas Fired Gravity Vent Unit Heater	1/2%-3%
Improvement with Automatic Flue Damper and Spark Pilot Added to Gravity Vent Unit Heater	8%

Annual Fuel Use

Annual fuel use may be determined for a building by using one of the following formulas:

Electric Resistance Heating

$$H/(\Delta T \times 3413 \times E) \times D \times 24 \times C_D = \text{KWH/YEAR}$$

Natural Gas Heating

$$H/(\Delta T \times 100,000 \times E) \times D \times 24 \times C_D = \text{THERMS/YEAR}$$

Propane Gas Heating

$$H/(\Delta T \times 21739 \times E) \times D \times 24 \times C_D = \text{POUNDS/YEAR}$$

$$H/(\Delta T \times 91911 \times E) \times D \times 24 \times C_D = \text{GALLONS/YEAR}$$

Oil Heating

$$H/(\Delta T \times 140,000 \times E) \times D \times 24 \times C_D = \text{GALLONS/YEAR}$$

Where: ΔT = Indoor Design Minus Outdoor Design Temp.

H = Building Heat Loss

D = Annual Degree Days

E = Seasonal Efficiency (See Above)

C_D = Correlation Factor C_D vs. Degree-Days

Annual Fuel Use (cont.)

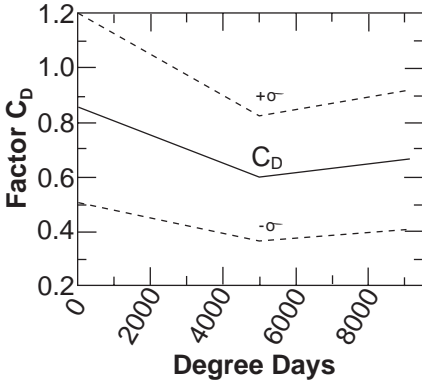

Pump Construction Types

The two general pump construction types are:

Bronze-fitted Pumps

- cast iron body
- brass impeller
- brass metal seal assembly components

Uses: Closed heating/chilled water systems, low-temp fresh water.

All-Bronze Pumps

- all wetted parts are bronze

Uses: Higher temp fresh water, domestic hot water, hot process water.

Pump Impeller Types

Single Suction - fluid enters impeller on one side only.

Double Suction - fluid enters both sides of impeller.

Closed Impeller - has a shroud which encloses the pump vanes, increasing efficiency. Used for fluid systems free of large particles which could clog impeller.

Semi-Open Impeller - has no inlet shroud. Used for systems where moderate sized particles are suspended in pumped fluid.

Open Impeller - has no shroud. Used for systems which have large particles suspended in pumped fluid, such as sewage or sludge systems.

Heating & Refrigeration

Pump Bodies

Two basic types of pump bodies are:

Horizontal Split Case - split down centerline of pump horizontal axis. Disassembled by removing top half of pump body. Pump impeller mounted between bearings at center of shaft. Requires two seals. Usually double suction pump. Suction and discharge are in straight-line configuration.

Vertical Split Case - single-piece body casting attached to cover plate at the back of pump by capscrews. Pump shaft passes through seal and bearing in coverplate. Impeller is mounted on end of shaft. Suction is at right angle to discharge.

Pump Mounting Methods

The three basic types of pump mounting arrangements are:

Base Mount-Long Coupled - pump is coupled to base-mount motor. Motor can be removed without removing the pump from piping system. Typically standard motors are used.

Base Mount-Close Coupled - pump impeller is mounted on base mount motor shaft. No separate mounting is necessary for pump. Usually special motor necessary for replacement. More compact than long-coupled pump.

Line Mount - mounted to and supported by system piping. Usually resilient mount motor. Very compact. Usually for low flow requirements.

Heating & Refrigeration

Affinity Laws for Pumps

Impeller Diameter	Speed	Specific Gravity (SG)	To Correct for	Multiply by
Constant	Variable	Constant	Flow	$\left(\frac{\text{New Speed}}{\text{Old Speed}} \right)$
			Head	$\left(\frac{\text{New Speed}}{\text{Old Speed}} \right)^2$
			BHP (or kW)	$\left(\frac{\text{New Speed}}{\text{Old Speed}} \right)^3$
Variable	Constant		Flow	$\left(\frac{\text{New Diameter}}{\text{Old Diameter}} \right)$
			Head	$\left(\frac{\text{New Diameter}}{\text{Old Diameter}} \right)^2$
			BHP (or kW)	$\left(\frac{\text{New Diameter}}{\text{Old Diameter}} \right)^3$
	Constant	Variable	BHP (or kW)	$\frac{\text{New SG}}{\text{Old SG}}$

Adapted from ASHRAE "Pocket Handbook", 1987.

Heating & Refrigeration

Pumping System Troubleshooting Guide

Complaint: Pump or System Noise

Possible Cause	Recommended Action
Shaft misalignment	<ul style="list-style-type: none">• Check and realign
Worn coupling	<ul style="list-style-type: none">• Replace and realign
Worn pump/motor bearings	<ul style="list-style-type: none">• Replace, check manufacturer's lubrication recommendations• Check and realign shafts
Improper foundation or installation	<ul style="list-style-type: none">• Check foundation bolting or proper grouting• Check possible shifting because of piping expansion/contraction• Realign shafts
Pipe vibration and/or strain caused by pipe expansion/contraction	<ul style="list-style-type: none">• Inspect, alter or add hangers and expansion provision to eliminate strain on pump(s)
Water velocity	<ul style="list-style-type: none">• Check actual pump performance against specified and reduce impeller diameter as required• Check for excessive throttling by balance valves or control valves.
Pump operating close to or beyond end point of performance curve	<ul style="list-style-type: none">• Check actual pump performance against specified and reduce impeller diameter as required
Entrained air or low suction pressure	<ul style="list-style-type: none">• Check expansion tank connection to system relative to pump suction• If pumping from cooling tower sump or reservoir, check line size• Check actual ability of pump against installation requirements• Check for vortex entraining air into suction line

Heating & Refrigeration

Pumping System Troubleshooting Guide (cont.)

Complaint: Inadequate or No Circulation

Possible Cause	Recommended Action
Pump running backward (3 phase)	<ul style="list-style-type: none">• Reverse any two-motor leads
Broken pump coupling	<ul style="list-style-type: none">• Replace and realign
Improper motor speed	<ul style="list-style-type: none">• Check motor nameplate wiring and voltage
Pump (or impeller diameter) too small	<ul style="list-style-type: none">• Check pump selection (impeller diameter) against specified system requirements
Clogged strainer(s)	<ul style="list-style-type: none">• Inspect and clean screen
System not completely filled	<ul style="list-style-type: none">• Check setting of PRV fill valve• Vent terminal units and piping high points
Balance valves or isolating valves improperly set	<ul style="list-style-type: none">• Check settings and adjust as required
Air-bound system	<ul style="list-style-type: none">• Vent piping and terminal units• Check location of expansion tank connection line relative to pump suction• Review provision for air elimination
Air entrainment	<ul style="list-style-type: none">• Check pump suction inlet conditions to determine if air is being entrained from suction tanks or sumps
Low available NPSH	<ul style="list-style-type: none">• Check NPSH required by pump• Inspect strainers and check pipe sizing and water temperature

Adapted from ASHRAE "Pocket Handbook", 1987.

Heating & Refrigeration

Pump Terms, Abbreviations and Conversion Factors

Term	Abbreviation	Multiply	By	To Obtain
Length	l	ft	0.3048	m
Area	A	ft ²	0.0929	m ²
Velocity	v	ft/s	0.3048	m/s
Volume	V	ft ³	0.0283	m ³
Flow rate	Q _v	gpm	0.2272	m ³ /h
		gpm	0.0631	L/s
Pressure	P	psi	6890	Pa
		psi	6.89	kPa
		psi	14.5	bar
Head (total)	H	ft	0.3048	m
NPSH	H	ft	0.3048	m
Output power (pump)	P _o	water hp (WHP)	0.7457	kW
Shaft power	P _s	BHP	0.7457	kW
Input power (driver)	P _i	kW	1.0	kW
Efficiency, %				
Pump	E _p	—	—	—
Equipment	E _e	—	—	—
Electric motor	E _m	—	—	—
Utilization	E _u	—	—	—
Variable speed drive	F _v	—	—	—
System Efficiency Index (decimal)	SEI	—	—	—
Speed	n	rpm	0.1047	rad/s
		rpm	0.0167	rps
Density	ρ	lb/ft ³	16.0	kg/m ³
Temperature	°	°F-32	5/9	°C

Adapted from ASHRAE "Pocket Handbook", 1987.

Heating & Refrigeration

Common Pump Formulas

Formula for	I-P Units
Head	$H = \text{psi} \times 2.31 / \text{SG}^* \text{ (ft)}$
Output power	$P_o = Q_v \times H \times \text{SG}^* / 3960 \text{ (hp)}$
Shaft power	$P_s = \frac{Q_v \times H \times \text{SG}^*}{39.6 \times E_p} \text{ (hp)}$
Input power	$P_i = P_s \times 74.6 / E_m \text{ (kw)}$
Utilization $Q_D =$ design flow $Q_A =$ actual flow $H_D =$ design head $H_A =$ actual head	$\eta_{\mu} = 100 \frac{Q_D H_D}{Q_A H_A}$

*SG = specific gravity

Water Flow and Piping

Pressure drop in piping varies approx as the square of the flow:

$$\frac{h_2}{h_1} = \left(\frac{Q_2}{Q_1} \right)^2$$

The velocity of water flowing in a pipe is

$$v = \frac{\text{gpm} \times 0.41}{d^2}$$

Where V is in ft/sec and d is inside diameter, in.

Nom size	1/2	3/4	1	1-1/4	1-1/2	2	2-1/2	3	4
ID in.	0.622	0.824	1.049	1.380	1.610	2.067	2.469	3.068	4.02
d^2	0.387	0.679	1.100	1.904	2.59	4.27	6.10	9.41	16.21

Quiet Water Flows

Nom size	1/2	3/4	1	1-1/4	1-1/2	2	2-1/2	3	4
Gpm	1.5	4.	8.	14	22	44	75	120	240

Six fps is a reasonable upper limit for water velocity in pipes. The relationship between pressure drop and flow rate can also be expressed:

$$h_2 = h_1 \times \left(\frac{Q_2}{Q_1} \right)^2 \text{ or } Q_2 = Q_1 \times \sqrt{\frac{h_2}{h_1}}$$

Heating & Refrigeration

Water Flow and Piping (cont.)

Example: If design values were 200 gpm and 40 ft head and actual flow were changed to 100 gpm, the new head would be:

$$h_2 = 40 \left(\frac{100}{200} \right)^2 = 10 \text{ ft}$$

$$\text{Pump hp} = \frac{\text{gpm} \times \text{ft head} \times \text{sp gr}}{3960 \times \% \text{ efficiency}}$$

Typical single suction pump efficiencies, %:

1/12 to 1/2 hp	40 to 55
3/4 to 2	45 to 60
3 to 10	50 to 65

double suction pumps:

20 to 50	60 to 80
----------	----------

Friction Loss for Water Flow

Average value—new pipe. Used pipe add 50%

Feet loss / 100 ft—schedule 40 pipe

US Gpm	1/2 in.		3/4 in.		1 in.		1-1/4 in.	
	v Fps	h _F FtHd	v Fps	h _F FtHd	v Fps	h _F FtHd	v Fps	h _F FtHd
2.0	2.11	5.5						
2.5	2.64	8.2						
3.0	3.17	11.2						
3.5	3.70	15.3						
4	4.22	19.7	2.41	4.8				
5	5.28	29.7	3.01	7.3				
6			3.61	10.2	2.23	3.1		
8			4.81	17.3	2.97	5.2		
10			6.02	26.4	3.71	7.9		
12					4.45	11.1	2.57	2.9
14					5.20	14.0	3.00	3.8
16					5.94	19.0	3.43	4.8

Heating & Refrigeration

Friction Loss for Water Flow (cont.)

US Gpm	1-1/2 in.		2 in.		2-1/2 in.		1-1/4 in.	
	v Fps	h _F FtHd	v Fps	h _F FtHd	v Fps	h _F FtHd	v Fps	h _F FtHd
18	2.84	2.8					3.86	6.0
20	3.15	3.4					4.29	7.3
22	3.47	4.1					4.72	8.7
24	3.78	4.8					5.15	10.3
26	4.10	5.5					5.58	11.9
28	4.41	6.3					6.01	13.7
30	4.73	7.2					6.44	15.6
35	5.51	9.6					7.51	20.9
40	6.30	12.4	3.82	3.6				
45	7.04	15.5	4.30	4.4				
50			4.78	5.4				
60			5.74	7.6	4.02	3.1		
70			6.69	10.2	4.69	4.2	3 in.	
80			7.65	13.1	5.36	5.4	v	h _F
100					6.70	8.2	Fps	FtHd
120					8.04	11.5	5.21	3.9
140					9.38	15.5	6.08	5.2
160							6.94	6.7
180							7.81	8.4
200							8.68	10.2

Adapted from "Numbers", Bill Holladay and Cy Otterholm, 1985

Heating & Refrigeration

Equivalent Length of Pipe for Valves and Fittings

Screwed fittings, turbulent flow only, equipment length in feet.

Fittings	Pipe Size							
	1/2	3/4	1	1-1/4	1-1/2	2	2-1/2	3
Standard 90° Ell	3.6	4.4	5.2	6.6	7.4	8.5	9.3	11
Long rad. 90° Ell	2.2	2.3	2.7	3.2	3.4	3.6	3.6	4.0
Standard 45° Ell	.71	.92	1.3	1.7	2.1	2.7	3.2	3.9
Tee Line flow	1.7	2.4	3.2	4.6	5.6	7.7	9.3	12
Tee Br flow	4.2	5.3	6.6	8.7	9.9	12	13	17
180° Ret bend	3.6	4.4	5.2	6.6	7.4	8.5	9.3	11
Globe Valve	22	24	29	37	42	54	62	79
Gate Valve	.56	.67	.84	1.1	1.2	1.5	1.7	1.9
Angle Valve	15	15	17	18	18	18	18	18
Swing Check	8.0	8.8	11	13	15	19	22	27
Union or Coupling	.21	.24	.29	.36	.39	.45	.47	.53
Bellmouth inlet	.10	.13	.18	.26	.31	.43	.52	.67
Sq mouth inlet	.96	1.3	1.8	2.6	3.1	4.3	5.2	6.7
Reentrant pipe	1.9	2.6	3.6	5.1	6.2	8.5	10	13
Sudden enlargement	Feet of liquid loss = $\frac{(V_1 - V_2)^2}{2g}$							

where V_1 & V_2 = entering and leaving velocities

and $g = 32.17 \text{ ft/sec}^2$

Adapted from "Numbers", Bill Holladay and Cy Otterholm, 1985

Heating & Refrigeration

Standard Pipe Dimensions

Schedule 40 (Steel)

Nominal Size	Diameter		Area ft ² / lin ft. Inside	Volume gal/lin ft.	Weight lb/lin ft
	Outside in.	Inside in.			
1/8	0.405	0.269	0.070	0.0030	0.244
1/4	0.540	0.364	0.095	0.0054	0.424
3/8	0.675	0.493	0.129	0.0099	0.567
1/2	0.840	0.622	0.163	0.0158	0.850
3/4	1.050	0.824	0.216	0.0277	1.13
1	1.315	1.049	0.275	0.0449	1.68
1-1/4	1.660	1.380	0.361	0.0777	2.27
1-1/2	1.900	1.610	0.422	0.1058	2.72
2	2.375	2.067	0.541	0.1743	3.65
2-1/2	2.875	2.469	0.646	0.2487	5.79
3	3.500	3.068	0.803	0.3840	7.57
4	4.500	4.026	1.054	0.6613	10.79
5	5.563	5.047	1.321	1.039	14.62
6	6.625	6.065	1.587	1.501	18.00

Copper Tube Dimensions

(Type L)

Nominal size	Diameter		Cross-sect Area sq.in. Inside	Volume gal/lin ft.	Weight lb/lin ft
	Outside in.	Inside in.			
1/4	0.375	0.315	0.078	0.00404	0.126
3/8	0.500	0.430	0.145	0.00753	0.198
1/2	0.625	0.545	0.233	0.0121	0.285
5/8	0.750	0.666	0.348	0.0181	0.362
3/4	0.875	0.785	0.484	0.0250	0.455
1	1.125	1.025	0.825	0.0442	0.655
1-1/4	1.375	1.265	1.26	0.0655	0.884
1-1/2	1.625	1.505	1.78	0.0925	1.14
2	2.125	1.985	3.10	0.161	1.75
2-1/2	2.625	2.465	4.77	0.247	2.48
3	3.125	2.945	6.81	0.354	3.33
4	4.125	3.905	12.0	0.623	5.38

Heating & Refrigeration

Typical Heat Transfer Coefficients

Controlling fluid and apparatus	Type of Exchanger	U free convection	U forced convection
Air - flat plates	Gas to gas ^a	0.6 -2	2-6
Air - bare pipes	Steam to air ^a	1-2	2-10
Air - fin coil	Air to water ^a	1-3	2-10
Air - HW radiator	Water to air ^a	1-3	2-10
Oil - preheater	Liquid to liquid	5-10	20-50
Air - aftercooler	Comp air to water ^b	5-10	20-50
Oil - preheater	Steam to liquid	10-30	25-60
Brine - flooded chiller	Brine to R12, R22		30-90
Brine - flooded chiller	Brine to NH ₃		45-100
Brine - double pipe	Brine to NH ₃		50-125
Water - double pipe	Water to NH ₃		50-150
Water - Baudelot cooler	Water to R12, R22		60-150
Brine - DX chiller	Brine to R12, R22, NH ₃		60-140
Brine - DX chiller	E glycol to R12, R22		100-170
Water - DX Baudelot	Water to R12, R22, R502		100-200
Water - DX Shell & tube	Water to R12, R22, NH ₃		130-190
Water - shell & int finned tube	Water to R12, R22		160-250
Water - shell & tube	Water to water		150-300
Water - shell & tube	Condensing vapor to water		150-800

Notes: U factor = Btu/h - ft² •°F
Liquid velocities 3 ft/sec or higher

^a At atmospheric pressure

^b At 100 psig

Values shown are for commercially clean equipment.

Adapted from "Numbers", Bill Holladay and Cy Otterholm, 1985.

Heating & Refrigeration

Fouling Factors

Recommended minimum fouling allowances (f)^a for water flowing at 3 ft/sec^b or higher:

Distilled water	0.0005
Water, closed system	0.0005
Water, open system	0.0010
Inhibited cooling tower	0.0015
Engine jacket	0.0015
Treated boiler feed (212°F)	0.0015
Hard well water	0.0030
Untreated cooling tower	0.0033

Steam:

Dry, clean and oil free	0.0003
Wet, clean and oil free	0.0005
Exhaust from turbine	0.0010

Brines:

	<i>Non-ferrous tubes</i>	<i>Ferrous tubes</i>
Methylene chloride	none	none
Inhibited salts	0.0005	0.0010
Non-inhibited salts	0.0010	0.0020
Inhibited glycols	0.0010	0.0020

Vapors and gases:

Refrigerant vapors	none
Solvent vapors	0.0008
Air, (clean) centrifugal compressor	0.0015
Air, reciprocating compressor	0.0030

Other Liquids:

Organic solvents (clean)	0.0001
Vegetable oils	0.0040
Quenching oils (filtered)	0.0050
Fuel oils	0.0060
Sea water	0.0005

^aInsert factor in:
$$U = \frac{1}{\frac{1}{h_1} + f_1 + f_2 + \frac{1}{h_2}}$$
 where f_1 and f_2 are the surface fouling factors.

^bLower velocities require higher f values.

Heating & Refrigeration

Cooling Tower Ratings†

Temperatures °F			
Hot Water	Cold Water	Wet Bulb	Capacity Factor
90	80	70	0.85
92	82	70	1.00
95	85	70	1.24
90	80	72	0.74
92	82	72	0.88
95	85	72	1.12
95	85	74	1.00
95	85	76	0.88
95	85	78	0.75
95	85	80	0.62

Hot water - Cold water = Range

Cold water - Wet bulb = Approach

The Capacity Factor is a multiplier by which the capacity at any common assumed condition may be found if the rating at some other point is known.

Factors are based on a Heat Rejection Ratio of 1.25 (15,000 Btu/hr • ton) and gpm/ton flow rate.

Example: at 95-85-80, the capacity is 0.62/0.85 or 0.73 that of the rating at 90-80-70.

Capacity is reduced as the flow rate per ton is increased.

If the refrigerant temperature is below 40°F, the heat rejection will be greater than 15,000 btu/hr • ton.

Evaporation will cause increasing deposit of solids and fouling of condenser tube unless water is bled off. A bleed of 1% of the circulation rate will result in a concentration of twice the original solids (two concentrations), and 0.5% bleed will result in three concentrations.

Horsepower per Ton†

at 100°F Condensing Temperature

Vapor enters Compressor at 65°F

Refrig. Temp., F	40	20	0	-20	-40
Practical Avg.	0.87	1.20	1.70	2.40	3.20

†Adapted from "Numbers", Bill Holladay and Cy Otterholm, 1985

Heating & Refrigeration

Evaporate Condenser Ratings†

An Evaporative Condenser rated at a condensing temperature of 100°F and a wet bulb temperature of 70°F will have rating factors under other conditions, as follows:

Cond. Temp., °F	Entering Air Wet Bulb Temp., °F					
	55°	60°	65°	70°	75°	78°
90	0.96	0.86	0.75	0.63	0.50	0.41
95	1.13	1.03	0.91	0.80	0.67	0.59
100	1.32	1.22	1.11	1.00	0.87	0.79
105	1.51	1.41	1.31	1.20	1.08	1.00
110	1.71	1.62	1.52	1.41	1.29	1.22
115	1.93	1.85	1.75	1.65	1.54	1.47
120	2.20	2.11	2.02	1.93	1.81	1.75

Compressor Capacity Vs. Refrigerant Temperature at 100°F Condensing†

Refrig. Temp. °F	Heat Rejection Ratio ^a	Capacity, % Based on			
		50°F	40°F	20°F	0°F
50	1.26	100			
40	1.28	83	100		
30	1.31	69	83		
20	1.35	56	67	100	
10	1.39	45	54	80	
0	1.45	36	43	64	100
-10	1.53	28	34	50	78
-20	1.64	22	26	39	61
-30	1.77	15	18	27	42
-40	1.92	10	12	18	28

^aFor sealed compressors.

The capacity of a typical compressor is reduced as the evaporating temperature is reduced because of increased specific volume (cu ft/lb) of the refrigerant and lower compressor volumetric efficiency. The average 1 hp compressor will have a capacity of nearly 12,000 btu/h, 1 ton, at 40°F refrigerant temperature, 100°F condensing temperature. A 10° rise/fall in condensing temperature will reduce/increase capacity about 6%.

†Adapted from "Numbers", Bill Holladay and Cy Otterholm, 1985

Heating & Refrigeration

Refrigerant Line Capacities for 134a†

Tons for 100 ft. - Type L. Copper, Suction Lines, $\Delta t = 2^\circ\text{F}$

Size O.D.	Saturated Suction Temp. °F/ Δp					Discharge Lines Δt 1°F	Liquid Lines Δt 1°F
	0 1.00	10 1.19	20 1.41	30 1.66	40 1.93		
1/2	0.14	0.18	0.23	0.29	0.35	0.54	2.79
5/8	0.27	0.34	0.43	0.54	0.66	1.01	5.27
7/8	0.71	0.91	1.14	1.42	1.75	2.67	14.00
1-1/8	1.45	1.84	2.32	2.88	3.54	5.40	28.40
1-3/8	2.53	3.22	4.04	5.02	6.17	9.42	50.00
1-5/8	4.02	5.10	6.39	7.94	9.77	14.90	78.60
2-1/8	8.34	10.60	13.30	16.50	20.20	30.80	163.00
2-5/8	14.80	18.80	23.50	29.10	35.80	54.40	290.00
3-1/8	23.70	30.00	37.50	46.40	57.10	86.70	462.00
3-5/8	35.10	44.60	55.80	69.10	84.80	129.00	688.00
4-1/8	49.60	62.90	78.70	97.40	119.43	181.00	971.00
5-1/8	88.90	113.00	141.00	174.00	213.00		
6-1/8	143.00	181.00	226.00	280.00	342.00		

Refrigerant Line Capacities for R-22†

Tons for 100 ft. - Type L. Copper, Suction Lines, $\Delta t = 2^\circ\text{F}$

Size O.D.	Saturated Suction Temp. °F/ Δp					Discharge Lines Δt 1°F	Liquid Lines Δt 1°F
	-40 0.79	-20 1.15	0 1.6	20 2.2	40 2.9		
1/2				0.40	0.6	0.8	3.6
5/8		0.32	0.51	0.76	1.1	1.5	6.7
7/8	0.52	0.86	1.3	2.0	2.9	4.0	18.2
1-1/8	1.1	1.7	2.7	4.0	5.8	8.0	37.0
1-3/8	1.9	3.1	4.7	7.0	10.1	14.0	64.7
1-5/8	3.0	4.8	7.5	11.1	16.0	22.0	102
2-1/8	6.2	10.0	15.6	23.1	33.1	45.6	213
2-5/8	10.9	17.8	27.5	40.8	58.3	80.4	377
3-1/8	17.5	28.4	44.0	65.0	92.9	128	602
3-5/8	26.0	42.3	65.4	96.6	138	190	896
4-1/8	36.8	59.6	92.2	136	194	268	1263
5-1/8	60.0	107	164	244	347	478	

*Tables are based on 105°F condensing temperature.

Refrigerant temperature has little effect on discharge line size. Steel pipe has about the same capacity as Type L. copper 1/8" larger.

†Adapted from ASHRAE Refrigeration Handbook 1998.

Heating & Refrigeration

Refrigerant Line Capacities for R-502†

Tons for 100 ft. - Type L. Copper, Suction Lines, $\Delta t = 2^\circ\text{F}$

Size Δp	Saturated Suction Temp. °F/ Δp					Discharge Lines Δt 1°F	Liquid Lines Δt 1°F
	-40 0.92	-20 1.33	0 1.84	20 2.45	40 3.18		
1/2	0.08	0.14	0.22	0.33	0.49	0.63	2.4
5/8	0.16	0.27	0.42	0.63	0.91	1.2	4.5
7/8	0.43	0.70	1.1	1.7	2.4	3.1	11.8
1-1/8	0.87	1.4	2.2	3.4	4.8	6.3	24.1
1-3/8	1.5	2.5	3.9	5.8	8.4	10.9	42.0
1-5/8	2.4	4.0	6.2	9.2	13.3	17.2	66.4
2-1/8	5.0	8.2	12.8	19.1	27.5	35.6	138
2-5/8	8.8	14.5	22.6	33.7	48.4	62.8	244
3-1/8	14.1	23.2	36.0	53.7	77.0	99.8	389
3-5/8	21.0	34.4	53.5	79.7	114	148	579
4-1/8	29.7	48.5	75.4	112	161	208	817
5-1/8	53.2	86.7	135	200	287	371	
6-1/8	85.6	140	216	321	461	596	

Refrigerant Line Capacities for R-717†

Tons for 100 ft. - Type L. Copper

R-717 (Ammonia) Tons for 100 Ft.							Δp	
IPS	Δp Sch	-40 0.31	-20 0.49	0 0.73	20 1.06	40 1.46	3	2
3/4	80				2.6	3.8		
1			2.1	3.4	5.2	7.6	13.9	106
1-1/4	40	3.2	5.6	8.9	13.6	19.9	36.5	229 ^a
1-1/2		4.9	8.4	13.4	20.5	29.9	54.8	349 ^a
2		9.5	16.2	26.0	39.6	57.8	106	811
2-1/2		15.3	25.9	41.5	63.2	92.1	168	1293
3		27.1	46.1	73.5	112	163	298	2288
4		55.7	94.2	150	229	333	600	4662
5		101	170	271	412	601	1095	
6		164	276	439	668	972	1771	

^aSchedule 80

†Adapted from ASHRAE Refrigeration Handbook 1998.

Formulas & Conversion Factors

Miscellaneous Formulas

OHMS Law

$$\text{Ohms} = \text{Volts/Amperes} (R = E/I)$$

$$\text{Amperes} = \text{Volts/Ohms} (I = E/R)$$

$$\text{Volts} = \text{Amperes} \times \text{Ohms} (E = IR)$$

Power—A-C Circuits

$$\text{Efficiency} = \frac{746 \times \text{Output Horsepower}}{\text{Input Watts}}$$

$$\text{Three-Phase Kilowatts} = \frac{\text{Volts} \times \text{Amperes} \times \text{Power Factor} \times 1.732}{1000}$$

$$\text{Three-Phase Volt-Amperes} = \text{Volts} \times \text{Amperes} \times 1.732$$

$$\text{Three-Phase Amperes} = \frac{746 \times \text{Horsepower}}{1.732 \times \text{Volts} \times \text{Efficiency} \times \text{Power Factor}}$$

$$\text{Three-Phase Efficiency} = \frac{746 \times \text{Horsepower}}{\text{Volts} \times \text{Amperes} \times \text{Power Factor} \times 1.732}$$

$$\text{Three-Phase Power Factor} = \frac{\text{Input Watts}}{\text{Volts} \times \text{Amperes} \times 1.732}$$

$$\text{Single-Phase Kilowatts} = \frac{\text{Volts} \times \text{Amperes} \times \text{Power Factor}}{1000}$$

$$\text{Single-Phase Amperes} = \frac{746 \times \text{Horsepower}}{\text{Volts} \times \text{Efficiency} \times \text{Power Factor}}$$

$$\text{Single-Phase Efficiency} = \frac{746 \times \text{Horsepower}}{\text{Volts} \times \text{Amperes} \times \text{Power Factor}}$$

$$\text{Single-Phase Power Factor} = \frac{\text{Input Watts}}{\text{Volts} \times \text{Amperes}}$$

$$\text{Horsepower (3 Ph)} = \frac{\text{Volts} \times \text{Amperes} \times 1.732 \times \text{Efficiency} \times \text{Power Factor}}{746}$$

$$\text{Horsepower (1 Ph)} = \frac{\text{Volts} \times \text{Amperes} \times \text{Efficiency} \times \text{Power Factor}}{746}$$

Power —D-C Circuits

$$\text{Watts} = \text{Volts} \times \text{Amperes} (W = EI)$$

$$\text{Amperes} = \frac{\text{Watts}}{\text{Volts}} (I = W/E)$$

$$\text{Horsepower} = \frac{\text{Volts} \times \text{Amperes} \times \text{Efficiency}}{746}$$

Formulas & Conversion Factors

Miscellaneous Formulas (cont.)

Speed—A-C Machinery

$$\text{Synchronous RPM} = \frac{\text{Hertz} \times 120}{\text{Poles}}$$

$$\text{Percent Slip} = \frac{\text{Synchronous RPM} - \text{Full-Load RPM}}{\text{Synchronous RPM}} \times 100$$

Motor Application

$$\text{Torque (lb.-ft.)} = \frac{\text{Horsepower} \times 5250}{\text{RPM}}$$

$$\text{Horsepower} = \frac{\text{Torque (lb.-ft.)} \times \text{RPM}}{5250}$$

Time for Motor to Reach Operating Speed (seconds)

$$\text{Seconds} = \frac{WK^2 \times \text{Speed Change}}{308 \times \text{Avg. Accelerating Torque}}$$

$$\text{Average Accelerating Torque} = \frac{[(\text{FLT} + \text{BDT})/2] + \text{BDT} + \text{LR1}}{3}$$

$$WK^2 = \text{Inertia of Rotor} + \text{Inertia of Load (lb.-ft.}^2\text{)}$$

$$\text{FLT} = \text{Full-Load Torque} \quad \text{BDT} = \text{Breakdown Torque}$$

$$\text{LRT} = \text{Locked Rotor Torque}$$

$$\text{Load } WK^2 \text{ (at motor shaft)} = \frac{WK^2 \text{ (Load)} \times \text{Load RPM}^2}{\text{Motor RPM}^2}$$

$$\text{Shaft Stress (P.S.I.)} = \frac{\text{HP} \times 321,000}{\text{RPM} \times \text{Shaft Dia.}^3}$$

Change in Resistance Due to Change in Temperature

$$R_C = R_H \times \frac{(K + T_C)}{(K + T_H)}$$

$$R_H = R_C \times \frac{(K + T_H)}{(K + T_C)}$$

- K = 234.5 - Copper
- = 236 - Aluminum
- = 180 - Iron
- = 218 - Steel

R_C = Cold Resistance (OHMS)

R_H = Hot Resistance (OHMS)

T_C = Cold Temperature (°C)

T_H = Hot Temperature (°C)

Formulas & Conversion Factors

Miscellaneous Formulas (cont.)

Vibration

$$D = .318 (V/f)$$

D = Displacement (Inches Peak-Peak)

$$V = \pi(f) (D)$$

V = Velocity (Inches per Second Peak)

$$A = .051 (f)^2 (D)$$

A = Acceleration (g's Peak)

$$A = .016 (f) (V)$$

f = Frequency (Cycles per Second)

Volume of Liquid in a Tank

$$\text{Gallons} = 5.875 \times D^2 \times H$$

D = Tank Diameter (ft.)

H = Height of Liquid (ft.)

Centrifugal Applications

Affinity Laws for Centrifugal Applications:

$$\frac{\text{Flow}_1}{\text{Flow}_2} = \frac{\text{RPM}_1}{\text{RPM}_2}$$

$$\frac{\text{Pres}_1}{\text{Pres}_2} = \frac{(\text{RPM}_1)^2}{(\text{RPM}_2)^2}$$

$$\frac{\text{BHP}_1}{\text{BHP}_2} = \frac{(\text{RPM}_1)^3}{(\text{RPM}_2)^3}$$

For Pumps

$$\text{BHP} = \frac{\text{GPM} \times \text{PSI} \times \text{Specific Gravity}}{1713 \times \text{Efficiency of Pump}}$$

$$\text{BHP} = \frac{\text{GPM} \times \text{FT} \times \text{Specific Gravity}}{3960 \times \text{Efficiency of Pump}}$$

For Fans and Blowers

$$\text{Tip Speed (FPS)} = \frac{D(\text{in}) \times \text{RPM} \times \pi}{720}$$

$$\text{Temperature: } ^\circ\text{F} = ^\circ\text{C} \left(\frac{9}{5} \right) + 32$$

$$^\circ\text{C} = (^\circ\text{F} - 32) \frac{5}{9}$$

$$\text{BHP} = \frac{\text{CFM} \times \text{PSF}}{33000 \times \text{Efficiency of Fan}}$$

$$\text{BHP} = \frac{\text{CFM} \times \text{PIW}}{6344 \times \text{Efficiency of Fan}}$$

$$\text{BHP} = \frac{\text{CFM} \times \text{PSI}}{229 \times \text{Efficiency of Fan}}$$

1 ft. of water = 0.433 PSI

1 PSI = 2.309 Ft. of water

Specify Gravity of Water = 1.0

Formulas & Conversion Factors

Miscellaneous Formulas (cont.)

Where:

BHP = Brake Horsepower

GPM = Gallons per Minute

FT = Feet

PSI = Pounds per Square Inch

PSIG = Pounds per Square Inch Gauge

PSF = Pounds per Square Foot

PIW = Inches of Water Gauge

Area and Circumference of Circles

Diameter (inches)	Area (sq.in.)	Area (sq. ft.)	Circumference (feet)
1	0.7854	0.0054	0.2618
2	3.142	0.0218	0.5236
3	7.069	0.0491	0.7854
4	12.57	0.0873	1.047
5	19.63	0.1364	1.309
6	28.27	0.1964	1.571
7	38.48	0.2673	1.833
8	50.27	0.3491	2.094
9	63.62	0.4418	2.356
10	78.54	0.5454	2.618
11	95.03	0.6600	2.880
12	113.1	0.7854	3.142
13	132.7	0.9218	3.403
14	153.9	1.069	3.665
15	176.7	1.227	3.927
16	201.0	1.396	4.189
17	227.0	1.576	4.451
18	254.7	1.767	4.712
19	283.5	1.969	4.974
20	314.2	2.182	5.236
21	346.3	2.405	5.498
22	380.1	2.640	5.760
23	415.5	2.885	6.021
24	452.4	3.142	6.283

Formulas & Conversion Factors

Area and Circumference of Circles (cont.)

Diameter (inches)	Area (sq.in.)	Area (sq. ft.)	Circumference (feet)
25	490.9	3.409	6.545
26	530.9	3.687	6.807
27	572.5	3.976	7.069
28	615.7	4.276	7.330
29	660.5	4.587	7.592
30	706.8	4.909	7.854
31	754.7	5.241	8.116
32	804.2	5.585	8.378
33	855.3	5.940	8.639
34	907.9	6.305	8.901
35	962.1	6.681	9.163
36	1017.8	7.069	9.425
37	1075.2	7.467	9.686
38	1134.1	7.876	9.948
39	1194.5	8.296	10.21
40	1256.6	8.727	10.47
41	1320.2	9.168	10.73
42	1385.4	9.621	10.99
43	1452.2	10.08	11.26
44	1520.5	10.56	11.52
45	1590.4	11.04	11.78
46	1661.9	11.54	12.04
47	1734.9	12.05	12.30
48	1809.5	12.57	12.57
49	1885.7	13.09	12.83
50	1963.5	13.64	13.09
51	2043	14.19	13.35
52	2124	14.75	13.61
53	2206	15.32	13.88
54	2290	15.90	14.14
55	2376	16.50	14.40
56	2463	17.10	14.66
57	2552	17.72	14.92

Formulas & Conversion Factors

Area and Circumference of Circles (cont.)

Diameter (inches)	Area (sq.in.)	Area (sq. ft.)	Circumference (feet)
58	2642	18.35	15.18
59	2734	18.99	15.45
60	2827	19.63	15.71
61	2922	20.29	15.97
62	3019	20.97	16.23
63	3117	21.65	16.49
64	3217	22.34	16.76
65	3318	23.04	17.02
66	3421	23.76	17.28
67	3526	24.48	17.54
68	3632	25.22	17.80
69	3739	25.97	18.06
70	3848	26.73	18.33
71	3959	27.49	18.59
72	4072	28.27	18.85
73	4185	29.07	19.11
74	4301	29.87	19.37
75	4418	30.68	19.63
76	4536	31.50	19.90
77	4657	32.34	20.16
78	4778	33.18	20.42
79	4902	34.04	20.68
80	5027	34.91	20.94
81	5153	35.78	21.21
82	5281	36.67	21.47
83	5411	37.57	21.73
84	5542	38.48	21.99
85	5675	39.41	22.25
86	5809	40.34	22.51
87	5945	41.28	22.78
88	6082	42.24	23.04
89	6221	43.20	23.30
90	6362	44.18	23.56
91	6504	45.17	23.82

Formulas & Conversion Factors

Area and Circumference of Circles (cont.)

Diameter (inches)	Area (sq.in.)	Area (sq. ft.)	Circumference (feet)
92	6648	46.16	24.09
93	6793	47.17	24.35
94	6940	48.19	24.61
95	7088	49.22	24.87
96	7238	50.27	25.13
97	7390	51.32	25.39
98	7543	52.38	25.66
99	7698	53.46	25.92
100	7855	54.54	26.18

Circle Formula

$$A(\text{in}^2) = \pi r (\text{in})^2 = \frac{\pi d(\text{in})^2}{4}$$

$$A(\text{ft}^2) = \frac{\pi r (\text{in})^2}{144} = \frac{\pi d(\text{in})^2}{576}$$

$$C(\text{ft}) = \frac{\pi d (\text{in})}{12}$$

Where: A = Area
C = Circumference
r = Radius
d = Diameter

Common Fractions of an Inch

Decimal and Metric Equivalents

Fraction	Decimal	mm	Fraction	Decimal	mm
1/64	0.01562	0.397	17/64	0.26562	6.747
1/32	0.03125	0.794	9/32	0.28125	7.144
3/64	0.04688	1.191	19/64	0.29688	7.541
1/16	0.06250	1.588	5/16	0.31250	7.938
5/64	0.07812	1.984	21/64	0.32812	8.334
3/32	0.09375	2.381	11/32	0.34375	8.731
7/64	0.10938	2.778	23/64	0.35938	9.128
1/8	0.12500	3.175	3/8	0.37500	9.525
9/64	0.14062	3.572	25/64	0.39062	9.922
5/32	0.15625	3.969	13/32	0.40625	10.319
11/64	0.17188	4.366	27/64	0.42188	10.716
3/16	0.18750	4.763	7/16	0.43750	11.113
13/64	0.20312	5.159	29/64	0.45312	11.509
7/32	0.21875	5.556	15/32	0.46875	11.906
15/64	0.23438	5.953	31/64	0.48438	12.303
1/4	0.25000	6.350	1/2	0.50000	12.700

Formulas & Conversion Factors

Common Fractions of an Inch (cont.)

Decimal and Metric Equivalents

Fraction	Decimal	mm	Fraction	Decimal	mm
33/64	0.51562	13.097	49/64	0.76562	19.447
17/32	0.53125	13.494	25/32	0.78125	19.844
35/64	0.54688	13.891	51/64	0.79688	20.241
9/16	0.56250	14.288	13/16	0.81250	20.638
37/64	0.57812	14.684	53/64	0.82812	21.034
19/32	0.59375	15.081	27/32	0.84375	21.431
39/64	0.60938	15.478	55/64	0.85938	21.828
5/8	0.62500	15.875	7/8	0.87500	22.225
41/64	0.64062	16.272	57/64	0.89062	22.622
21/32	0.65625	16.669	29/32	0.90625	23.019
43/64	0.67188	17.066	59/64	0.92188	23.416
11/16	0.68750	17.463	15/16	0.93750	23.813
45/64	0.70312	17.859	61/64	0.95312	24.209
23/32	0.71875	18.256	31/32	0.96875	24.606
47/64	0.73438	18.653	63/64	0.98438	25.004
3/4	0.75000	19.050	1/1	1.00000	25.400

Conversion Factors

Multiply Length		By		To Obtain
centimeters	x	.3937	=	Inches
fathoms	x	6.0	=	Feet
feet	x	12.0	=	Inches
feet	x	.3048	=	Meters
inches	x	2.54	=	Centimeters
kilometers	x	.6214	=	Miles
meters	x	3.281	=	Feet
meters	x	39.37	=	Inches
meters	x	1.094	=	Yards
miles	x	5280.0	=	Feet
miles	x	1.609	=	Kilometers
rods	x	5.5	=	Yards
yards	x	.9144	=	Meters

Formulas & Conversion Factors

Conversion Factors (cont.)

Multiply Area		By	To Obtain
acres	x	4047.0	= Square meters
acres	x	.4047	= Hectares
acres	x	43560.0	= Square feet
acres	x	4840.0	= Square yards
circular mils	x	7.854×10^{-7}	= Square inches
circular mils	x	.7854	= Square mils
hectares	x	2.471	= Acres
hectares	x	1.076×10^5	= Square feet
square centimeters	x	.155	= Square inches
square feet	x	144.0	= Square inches
square feet	x	.0929	= Square meters
square inches	x	6.452	= Square cm.
square meters	x	1.196	= Square yards
square meters	x	2.471×10^{-4}	= Acres
square miles	x	640.0	= Acres
square mils	x	1.273	= Circular mils
square yards	x	.8361	= Square meters
Multiply Volume		By	To Obtain
cubic feet	x	.0283	= Cubic meters
cubic feet	x	7.481	= Gallons
cubic inches	x	.5541	= Ounces (fluid)
cubic meters	x	35.31	= Cubic feet
cubic meters	x	1.308	= Cubic yards
cubic yards	x	.7646	= Cubic meters
gallons	x	.1337	= Cubic feet
gallons	x	3.785	= Liters
liters	x	.2642	= Gallons
liters	x	1.057	= Quarts (liquid)
ounces (fluid)	x	1.805	= Cubic inches
quarts (fluid)	x	.9463	= Liters

Formulas & Conversion Factors

Conversion Factors (cont.)

Multiply Force & Weight		By	To Obtain
grams	x	.0353	= Ounces
kilograms	x	2.205	= Pounds
newtons	x	.2248	= Pounds (force)
ounces	x	28.35	= Grams
pounds	x	453.6	= Grams
pounds (force)	x	4.448	= Newton
tons (short)	x	907.2	= Kilograms
tons (short)	x	2000.0	= Pounds
Multiply Torque		By	To Obtain
gram-centimeters	x	.0139	= Ounce-inches
newton-meters	x	.7376	= Pound-feet
newton-meters	x	8.851	= Pound-inches
ounce-inches	x	71.95	= Gram-centimeters
pound-feet	x	1.3558	= Newton-meters
pound-inches	x	.113	= Newton-meters
Multiply Energy or Work		By	To Obtain
Btu	x	778.2	= Foot-pounds
Btu	x	252.0	= Gram-calories
Multiply Power		By	To Obtain
Btu per hour	x	.293	= Watts
horsepower	x	33000.0	= Foot-pounds per minute
horsepower	x	550.0	= Foot-pounds per second
horsepower	x	746.0	= Watts
kilowatts	x	1.341	= Horsepower
Multiply Plane Angle		By	To Obtain
degrees	x	.0175	= Radians
minutes	x	.01667	= Degrees
minutes	x	2.9×10^{-4}	= Radians
quadrants	x	90.0	= Degrees
quadrants	x	1.5708	= Radians
radians	x	57.3	= Degrees

Pounds are U.S. avoirdupois.
Gallons and quarts are U.S.

Formulas & Conversion Factors

Conversion Factors (cont.)

Multiply	By	To obtain
acres	x 0.4047	= ha
atmosphere, standard	x *101.35	= kPa
bar	x *100	= kPa
barrel (42 US gal. petroleum)	x 159	= L
Btu (International Table)	x 1.055	= kJ
Btu/ft ²	x 11.36	= kJ/m ²
Btu·ft/h·ft ² ·°F	x 1.731	= W/(m·K)
Btu·in/h·ft ² ·°F (thermal conductivity, k)	x 0.1442	= W/(m·K)
Btu/h	x 0.2931	= W
Btu/h·ft ²	x 3.155	= W/m ²
Btu/h·ft ² ·°F (heat transfer coefficient, U)	x 5.678	= W/(m ² ·K)
Btu/lb	x *2.326	= kJ/kg
Btu/lb·°F (specific heat, c _p)	x 4.184	= kJ/(kg·K)
bushel	x 0.03524	= m ³
calorie, gram	x 4.187	= J
calorie, kilogram (kilocalorie)	x 4.187	= kJ
centipoise, dynamic viscosity, μ	x *1.00	= mPa·s
centistokes, kinematic viscosity, ν	x *1.00	= mm ² /s
dyne/cm ²	x *0.100	= Pa
EDR hot water (150 Btu/h)	x 44.0	= W
EDR steam (240 Btu/h)	x 70.3	= W
fuel cost comparison at 100% eff.		
cents per gallon (no. 2 fuel oil)	x 0.0677	= \$/GJ
cents per gallon (no. 6 fuel oil)	x 0.0632	= \$/GJ
cents per gallon (propane)	x 0.113	= \$/GJ
cents per kWh	x 2.78	= \$/GJ
cents per therm	x 0.0948	= \$/GJ
ft/min, fpm	x *0.00508	= m/s

* Conversion factor is exact.

Formulas & Conversion Factors

Conversion Factors (cont.)

Multiply	By	To obtain
ft/s, fps	x 0.3048	= m/s
ft of water	x 2.99	= kPa
ft of water per 100 ft of pipe	x 0.0981	= kPa/m
ft ²	x 0.09290	= m ²
ft ² ·h·°F/Btu (thermal resistance, R)	x 0.176	= m ² ·K/W
ft ² /s, kinematic viscosity, ν	x 92 900	= mm ² /s
ft ³	x 28.32	= L
ft ³	x 0.02832	= m ³
ft ³ /h, cfh	x 7.866	= mL/s
ft ³ /min, cfm	x 0.4719	= L/s
ft ³ /s, cfs	x 28.32	= L/s
footcandle	x 10.76	= lx
ft·lb _f (torque or moment)	x 1.36	= N·m
ft·lb _f (work)	x 1.36	= J
ft·lb _f / lb (specific energy)	x 2.99	= J/kg
ft·lb _f / min (power)	x 0.0226	= W
gallon, US (*231 in ³)	x 3.7854	= L
gph	x 1.05	= mL/s
gpm	x 0.0631	= L/s
gpm/ft ²	x 0.6791	= L/(s·m ²)
gpm/ton refrigeration	x 0.0179	= mL/J
grain (1/7000 lb)	x 0.0648	= g
gr/gal	x 17.1	= g/m ³
horsepower (boiler)	x 9.81	= kW
horsepower (550 ft·lb _f /s)	x 0.746	= kW
inch	x *25.4	= mm
in of mercury (60°F)	x 3.377	= kPa
in of water (60°F)	x 248.8	= Pa
in/100 ft (thermal expansion)	x 0.833	= mm/m
in·lb _f (torque or moment)	x 113	= mN·m
in ²	x 645	= mm ²

*Conversion factor is exact.

Formulas & Conversion Factors

Conversion Factors (cont.)

Multiply	By	To obtain
in ³ (volume)	x 16.4	= mL
in ³ /min (SCIM)	x 0.273	= mL/s
in ³ (section modulus)	x 16 400	= mm ³
in ⁴ (section moment)	x 416 200	= mm ⁴
km/h	x 0.278	= m/s
kWh	x *3.60	= MJ
kW/1000 cfm	x 2.12	= kJ/m ³
kilopond (kg force)	x 9.81	= N
kip (1000 lb _f)	x 4.45	= kN
kip/in ² (ksi)	x 6.895	= MPa
knots	x 1.151	= mph
litre	x *0.001	= m ³
micron (μm) of mercury (60°F)	x 133	= mPa
mile	x 1.61	= km
mile, nautical	x 1.85	= km
mph	x 1.61	= km/h
mph	x 0.447	= m/s
mph	x 0.8684	= knots
millibar	x *0.100	= kPa
mm of mercury (60°F)	x 0.133	= kPa
mm of water (60°F)	x 9.80	= Pa
ounce (mass, avoirdupois)	x 28.35	= g
ounce (force of thrust)	x 0.278	= N
ounce (liquid, US)	x 29.6	= mL
ounce (avoirdupois) per gallon	x 7.49	= kg/m ³
perm (permeance)	x 57.45	= ng/(s·m ² ·Pa)
perm inch (permeability)	x 1.46	= ng/(s·m·Pa)
pint (liquid, US)	x 473	= mL
pound		
lb (mass)	x 0.4536	= kg
lb (mass)	x 453.6	= g
lb _f (force or thrust)	x 4.45	= N

*Conversion factor is exact.

Formulas & Conversion Factors

Conversion Factors (cont.)

Multiply		By	To obtain
lb/ft (uniform load)	x	1.49	= kg/m
lb _m /(ft·h) (dynamic viscosity, μ)	x	0.413	= mPa·s
lb _m /(ft·s) (dynamic viscosity, μ)	x	1490	= mPa·s
lb _f s/ft ² (dynamic viscosity, μ)	x	47 880	= mPa·s
lb/min	x	0.00756	= kg/s
lb/h	x	0.126	= g/s
lb/h (steam at 212°F)	x	0.284	= kW
lb _f /ft ²	x	47.9	= Pa
lb/ft ²	x	4.88	= kg/m ²
lb/ft ³ (density, ρ)	x	16.0	= kg/m ³
lb/gallon	x	120	= kg/m ³
ppm (by mass)	x	*1.00	= mg/kg
psi	x	6.895	= kPa
quart (liquid, US)	x	0.946	= L
square (100 ft ²)	x	9.29	= m ²
tablespoon (approx.)	x	15	= mL
teaspoon (approx.)	x	5	= mL
therm (100,000 Btu)	x	105.5	= MJ
ton, short (2000 lb)	x	0.907	= mg; t (tonne)
ton, refrigeration (12,000 Btu/h)	x	3.517	= kW
torr (1 mm Hg at 0°C)	x	133	= Pa
watt per square foot	x	10.8	= W/m ²
yd	x	0.9144	= m
yd ²	x	0.836	= m ²
yd ³	x	0.7646	= m ³

* Conversion factor is exact.

Note:

In this list the kelvin (K) expresses temperature intervals. The degree Celsius symbol (°C) is often used for this purpose as well.

Formulas & Conversion Factors

Psychrometric Chart

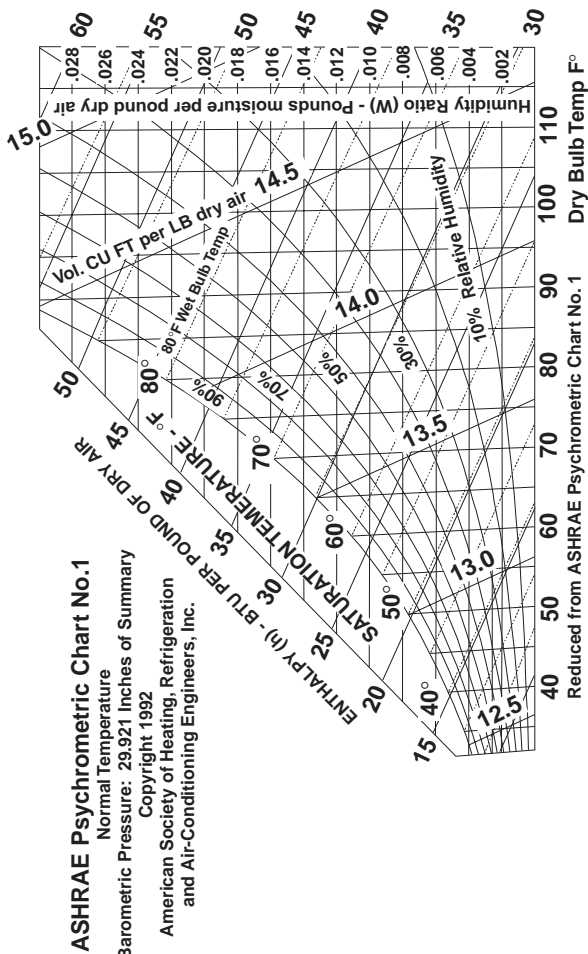

- A
 - Affinity Laws for Centrifugal Applications 83
 - For Fans and Blowers 83
 - For Pumps 83
 - Affinity Laws for Pumps 66
 - Air Change Method 40
 - Air Density Factors for Altitude and Temperature 3
 - Air Quality Method 40
 - Airfoil Applications 5
 - Allowable Ampacities of Not More Than Three Insulated Conductors 24–25
 - Alternating Current 16
 - Annual Fuel Use 63–64
 - Appliance Gas-Burning, Floor Mounted Type 45
 - Area and Circumference of Circles 84–87
 - Axial Fan Types 1
- B
 - Backdraft or Relief Dampers 49
 - Backward Inclined, Backward Curved Applications 6
 - Bearing Life 28
 - Belt Drive Guidelines 26
 - Belt Drives 26
 - Breakdown Torque 16
- C
 - Cell-Type Air Washers 53
 - Centrifugal Fan Types 1
 - Centrifugal Fan Conditions
 - Typical Inlet Conditions 14
 - Typical Outlet Conditions 14
 - Change in Resistance Due to Change in Temperature 82
 - Circle Formula 87
 - Classifications for Spark Resistant Construction 4–5
 - Construction Type 4
 - Notes 4–5
 - Standard Applications 5
 - Closed Impeller 64

INDEX

- Common Fractions of an Inch 87
- Compressor Capacity Vs. Refrigerant Temperature at 100°F
 Condensing 78
- Conversion Factors 88–94
- Cooling Load Check Figures 59–60
- Cooling Tower Ratings 77
- Copper Tube Dimensions (Type L) 74
- D
- Damper Pressure Drop 49
- Decimal and Metric Equivalents 87–88
- Dehumidifying Coils 53
- Design Criteria for Room Loudness 35–36
- Double Suction 64
- Drive Arrangements for Centrifugal Fans 9–10
 - Arr. 1 SWSI 9
 - Arr. 10 SWSI 10
 - Arr. 2 SWSI 9
 - Arr. 3 DWDI 9
 - Arr. 3 SWSI 9
 - Arr. 4 SWSI 9
 - Arr. 7 DWDI 10
 - Arr. 7 SWSI 9
 - Arr. 8 SWSI 10
 - Arr. 9 SWSI 10
- Duct Resistance 51
- E
- Efficiency 16
- Electric Coils 53
- Electric, Floor Mounted Type 45
- Electrical Appliances 46
- Electronic Air Cleaners 53
- Equivalent Length of Pipe for Valves and Fittings 73
- Estimated Belt Drive Loss 27
- Estimated Seasonal Efficiencies of Heating Systems 63
- Evaporate Condenser Ratings 78
- Exhaust Louvers 53

F**Fan Basics**

Fan Selection Criteria 1

Fan Types 1

Impeller Designs - Axial 7

Fan Installation Guidelines 14

Centrifugal Fan Conditions 14

Fan Laws 2**Fan Performance Tables and Curves 2****Fan Selection Criteria 1****Fan Testing - Laboratory, Field 2****Fan Troubleshooting Guide 15**

Excessive Vibration and Noise 15

Low Capacity or Pressure 15

Overheated Bearings 15

Overheated Motor 15

Fan Types 1

Axial Fan 1

Centrifugal Fan 1

Filter Comparison 46

Filter Type 46

For Pumps 83**Forward Curved Applications 6****Fouling Factors 76****Frequency Variations 23****Friction Loss for Water Flow 71–72****Fuel Comparisons 62****Fuel Gas Characteristics 62****Full Load Current 21–22**

Single Phase Motors 21

Three Phase Motors 22

G**Gas-Burning Appliances 46****General Ventilation 29**

INDEX

- H
 - Heat Gain From Occupants of Conditioned Spaces 43
 - Typical Application 43
 - Heat Gain From Typical Electric Motors 44
 - Heat Loss Estimates 61–62
 - Considerations Used for Corrected Values 62
 - Heat Removal Method 40
 - High-Velocity, Spray-Type Air Washers 53
 - Horizontal Split Case 65
 - Horsepower 16
 - Horsepower per Ton 77
- I
 - Impeller Designs - Axial
 - Propeller 7
 - Tube Axial 7
 - Vane Axial 7
 - Impeller Designs - Centrifugal 5–6
 - Airfoil 5
 - Backward Inclined, Backward Curved 6
 - Forward Curved 6
 - Radial 6
- Inadequate or No Circulation 68
- Induction Motor Characteristics 23
- Intake Louvers 53
- K
 - Kitchen Ventilation 30
 - Fans 30
 - Filters 30
 - Hoods and Ducts 30
- L
 - Locked Rotor KVA/HP 19
 - Locked Rotor Torque 16

M

- Miscellaneous Formulas 81–84
- Moisture and Air Relationships 57
- Motor and Drive Basics Definitions and Formulas 16
- Motor Application 82
- Motor Efficiency and EPA Act 20
- Motor Insulation Classes 18
- Motor Positions for Belt or Chain Drive 13
- Motor Service Factors 19

N

- Noise Criteria 32
- Noise Criteria Curves 34

O

- OHMS Law 81
- Open Impeller 64
- Optimum Relative Humidity Ranges for Health 48

P

- Panel Filters 53
- Power —D-C Circuits 81
- Power —A-C Circuits 81
- Process Ventilation 29
- Propeller Applications 7
- Properties of Saturated Steam 58
- Pump Bodies 65
- Pump Construction Types
 - All-Bronze Pumps 64
 - Bronze-fitted Pumps 64
- Pump Impeller Types 64
- Pump Mounting Methods 65
 - Base Mount-Close Coupled 65
 - Base Mount-Long Coupled 65
 - Line Mount 65
- Pump or System Noise 67
- Pump Terms, Abbreviations, and Conversion Factors 69
- Pumping System Troubleshooting Guide 67–68
- Psychometric Chart 95

INDEX

- Q
- Quiet Water Flows 70
- R
- Radial Applications 6
- Rate of Heat Gain Commercial Cooking Appliances in Air-Conditioned Area 45
- Rate of Heat Gain From Miscellaneous Appliances 46
- Rated Load Torque 16
- Recommended Metal Gauges for Ducts 56
- Rectangular Equivalent of Round Ducts 52
- Refrigerant Line Capacities for 134a 79
- Refrigerant Line Capacities for R-22 79
- Refrigerant Line Capacities for R-502 80
- Refrigerant Line Capacities for R-717 80
- Relief or Backdraft Dampers 49
- Renewable Media Filters 53
- Room Sones —dBA Correlation 33
- Room Type 35–36
 - Auditoriums 35
 - Churches and schools 35
 - Hospitals and clinics 35
 - Hotels 36
 - Indoor sports activities 35
 - Manufacturing areas 35
 - Miscellaneous 36
 - Offices 35
 - Public buildings 36
 - Residences 36
 - Restaurants, cafeterias, lounges 36
 - Retail stores 36
 - Transportation 36
- Rotation & Discharge Designations 11–12
- Rules of Thumb 31–32

S

- Screen Pressure Drop 50
- Single Phase AC 16
- Single Phase AC Motors 17
- Single Suction 64
- Sound 31
 - Sound Power 31
 - Sound Power Level 31
- Sound Power and Sound Power Level 32
- Sound Pressure and Sound Pressure Level 33
- Speed—A-C Machinery 82
- Spray-Type Air Washers 53
- Standard Pipe Dimensions Schedule 40 (Steel) 74
- Standard Pipe Dimensions 74
- Steam and Hot Water Coils 53
- Suggested Air Changes 41
- Synchronous speed 16
- System Design Guidelines

T

- Terminology for Centrifugal Fan Components 8
- Three Phase AC 16
- Three-phase AC Motors 17
- Time for Motor to Reach Operating Speed (seconds) 82
- Torque 16
- Tube Axial Applications 7
- Types of Alternating Current Motors 17–18
 - Three-phase AC Motors 17
- Types of Current Motors ??–18
- Typical Design Velocities for HVAC Components 53
- Typical Heat Transfer Coefficients 75

U

- U.S. Sheet Metal Gauges 55
- Use of Air Density Factors - An Example 3

INDEX

- V
- Vane Axial
 - Applications 7
- V-belt Length Formula 26
- Velocity and Velocity Pressure Relationships 54
- Ventilation Rates for Acceptable Indoor Air Quality 42
- Vertical Split Case 65
- Vibration 37, 83
 - System Natural Frequency 37
- Vibration Severity 38–39
 - Vibration Severity Chart 38
- Voltage 23
- Volume of Liquid in a Tank 83
- W
- Water Flow and Piping 70–71
- Wind Driven Rain Louvers 56